

FT-3500

ELECTROMAGNETIC FLOW METER Installation and Operation Guide



SAFETY INFORMATION

This meter was calibrated at the factory before shipment. To ensure correct use of the meter, please read this manual thoroughly.

Regarding this Manual:

- This manual should be passed on to the end user.
- Before use, read this manual thoroughly to comprehend its contents.
- The contents of this manual may be changed without prior notice.
- All rights reserved. No part of this manual may be reproduced in any form without ONICON's written permission.
- ONICON makes no warranty of any kind with regard to this material, including, but not limited to, implied warranties of merchantability and suitability for a particular purpose.
- All reasonable effort has been made to ensure the accuracy of the contents of this manual. However, if any errors are found, please inform ONICON.
- ONICON assumes no responsibilities for this product except as stated in the warranty.
- If the customer or any third party is harmed by the use of this product, ONICON assumes no responsibility for any such harm owing to any defects in the product which were not predictable, or for any indirect damages.

SAFETY PRECAUTIONS:

The following general safety precautions must be observed during all phases of installation, operation, service, and repair of this product. Failure to comply with these precautions or with specific WARNINGS given elsewhere in this manual violates safety standards of design, manufacture, and intended use of the product. ONICON Incorporated assumes no liability for the customer's failure to comply with these requirements. If this product is used in a manner not specified in this manual, the protection provided by this product may be impaired.

The following messages are used in this manual:

WARNING

Messages identified as "WARNING" contain information regarding the personal safety of individuals involved in the installation, operation or service of this product.

CAUTION

Messages identified as "CAUTION" contain information regarding potential damage to the product or other ancillary products.

IMPORTANT NOTE

Messages identified as "IMPORTANT NOTE" contain information critical to the proper operation of the product.

TABLE OF CONTENTS

SECTION 1.0 INTRODUCTION 4

 1.1 PURPOSE OF THIS GUIDE 4

 1.2 TYPICAL INSERTION ELECTROMAGNETIC FLOW METER 4

 1.2.1 Typical Meter Installation..... 5

 1.3 STANDARD FEATURES AND SPECIFICATIONS 6

 1.4 ADDITIONAL REQUIRED HARDWARE 7

 1.5 ADDITIONAL HARDWARE THAT MAY BE REQUIRED 8

 1.5.1 Grounding Rings 8

 1.5.2 Grounding Probes 9

 1.5.3 The Temperature Sensors 9

 1.5.4 Thermowell Installation 10

 1.5.4.1 Dry Tap Thermowells 10

 1.5.4.2 Hot Tap Thermowells 10

 1.5.5 Thermowells for 4-wire RTDs 12

 1.5.5.1 5mm Diameter Thermowell 12

 1.5.5.2 6mm Diameter Thermowell 13

SECTION 2.0 UNPACKING 14

 2.1 CHECKING THAT YOU HAVE RECEIVED EVERYTHING 14

SECTION 3.0 INSTALLATION, REMOVAL & ADJUSTMENT 15

 3.1 INSTALLATION SITE SELECTION 15

 3.2 MECHANICAL INSTALLATION 17

 3.2.1 Installation Kit 18

 3.2.2 ONICON Standard Installation Hardware Kit 18

 3.2.3 ONICON Hot Tap Installation Hardware Kit 18

 3.2.4 Customer Supplied Installation Hardware 19

 3.2.5 Confirming the Stack Height 20

 3.2.6 Installing Grounding Rings (non-conductive or lined pipes only) 21

 3.2.7 Installing the Flow Meter 22

 3.3 INSERTION OF THE METER 23

 3.3.1 Inserting Standard Configuration (≥3 inch) Flow Meters 23

 3.3.2 Inserting Small Pipe Flow Meters (1 1/4" -2 1/2") 24

 3.4 REMOVAL OF THE METER 25

 3.5 WIRING CONNECTIONS 26

 3.5.1 Input Power and Sensor Connection 26

 3.5.2 Signal Outputs 27

 3.5.3 Temperature Sensor Connection (For Energy Version Only) 28

 3.5.4 Network Communications Outputs 29

 3.5.5 Other Connections 30

 3.6 SIGNAL AND POWER WIRING CONNECTIONS 31

 3.6.1 Earth Connection 31

SECTION 4.0 PROGRAMMING MENU 32

SECTION 5.0 START-UP & COMMISSIONING 48

 5.1 HELPFUL HINTS FOR START-UP AND COMMISSIONING 48

 5.2 START-UP AND COMMISSIONING 49

 5.3 START-UP AND COMMISSIONING WORKSHEET 50

 5.4 NETWORK CONFIGURATION 51

 5.5 TROUBLESHOOTING GUIDE 57

 5.5.1 Earth Connections & Electrical Noise Reduction 58

SECTION 6.0 ERRORS 60

SECTION 7.0 ALARMS 63

SECTION 8.0 WARNINGS 64

APPENDIX 1 INPUT POWER AND SENSOR CONNECTION FOR DEC 2024/JAN 2025 CABLE VARIANT 68

SECTION 1.0: INTRODUCTION

We, at ONICON Incorporated, would like to thank you for purchasing our quality American made FT-3500 Electromagnetic Flow Meter. As our valued customer, our commitment to you is to provide fast reliable service, while continuing to offer you quality products to meet your growing flow measurement needs.

1.1 PURPOSE OF THIS GUIDE

We have written this guide to provide the persons responsible for the installation, operation and maintenance of your flow meter with the most specific equipment information they will need. This is NOT an electrical or plumbing trade manual.

WARNING

Please do not permit persons to install, operate or maintain this equipment unless they have a complete knowledge of their trade skills and are competent to work on high pressure hot and cold water and steam systems, according to their individual trades. Death or permanent injury may result from accidents with these systems.

This guide is the basic reference tool for all ONICON FT-3500 Electromagnetic Flow Meters. If you have not purchased all of the options, there will be references in this manual which are not applicable to your meter(s).

1.2 TYPICAL INSERTION ELECTROMAGNETIC FLOW METER

Faraday's Law of electromagnetic induction states that a voltage will be induced in a conductor when it passes through a magnetic field, and the induced voltage will be directly proportional to the velocity of the conductor.

ONICON FT-3500 Electromagnetic Flow Meters generate pulsating magnetic fields that are used to induce a voltage into the conductive fluid flowing through the pipe. Electrodes located on the flow meter sensor head measure the induced voltage. Circuitry within the remote transmitter electronics enclosure then converts the voltage to digital and analog signals and network communication that convey flow rate, total volume, and thermal energy.

1.2.1 Typical Meter Installation

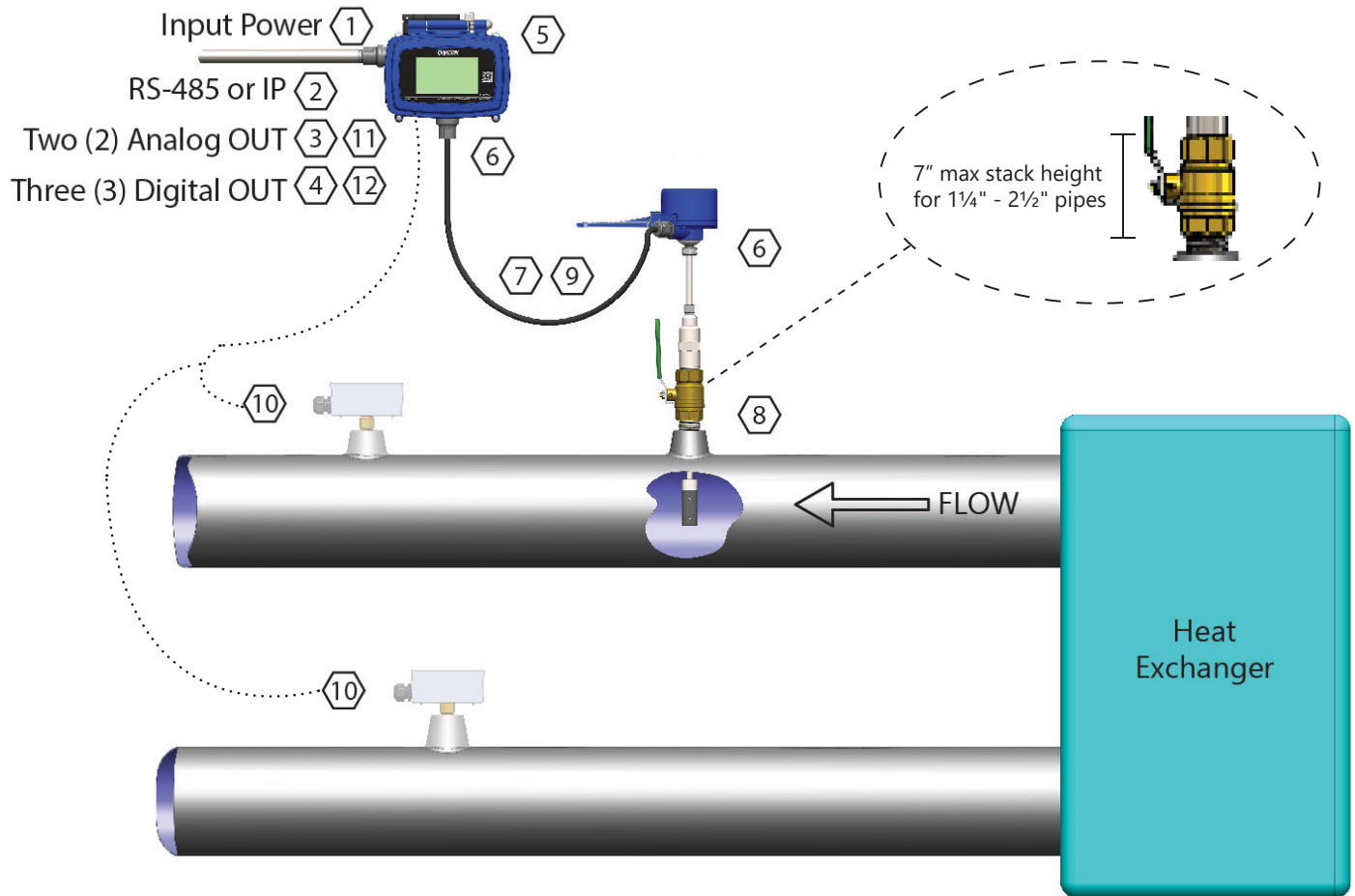

Notes:

1. Provide a Class II Input Power 20-28V AC/DC, 60 Hz.
2. BACnet MSTP, IP or MODBUS RTU, TCP/IP.
3. Active Analog outputs, do not provide power.
4. Digital Outputs are available for flow totals, operating modes (flow direction), and alarms.
5. Remote wall mount aluminum cast NEMA 4 Touch screen display.
6. Optional 1/2" FNPT waterproof conduit connectors.
7. ONICON provided cable, direct burial rated. The remote cable is available in 25ft, 50ft, 100ft, 150ft, or 200ft.
8. Order ONICON Installation kits separately. Installation kits vary based on pipe material and application. For installations in pressurized (live) systems, use "Hot Tap Installation Kit" and drill hole using a 1" wet tap drill.
9. Allow enough slack in the flexible conduit to permit the meter to be removed from the valve.

When ordered as a thermal energy (BTU) meter:

10. ONICON temperature sensors and thermowell kits ordered separately.
11. Analog outputs are available for energy rate, flow rate, supply, return, or delta temperature.
12. Digital outputs are available for energy totals, flow totals, operating modes, and alarms.

1.3 STANDARD FEATURES AND SPECIFICATIONS

PERFORMANCE	ACCURACY	Standard Sensor ±1.0% of reading from 2 - 20 ft/s ±0.02 ft/s below 2 ft/s Small Pipe Sensor ±1.0% of reading from 1.6 - 16 ft/s ±0.016 ft/s below 1.6 ft/s
	FLOW RANGE	Standard sensor: 0.1 ft/s to 20 ft/s Small pipe sensor: 0.08 ft/s to 16 ft/s
	SENSING METHOD	Electromagnetic sensing (no moving parts)
OPERATING CONDITIONS	MINIMUM CONDUCTIVITY	25 µS/cm
	FLUID TEMPERATURE RANGE	15°F to 250°F
	FLUID PRESSURE RANGE	400psi maximum
	AMBIENT CONDITIONS	Board: -20°F to 150°F
PRESSURE DROP	Standard Configuration: 0.1 psi at 12 ft/s in 3" pipe, decreasing as line size increases	
	Small Pipe Configuration: 0.33 psi at 8 ft/s in 1.25" pipe, decreasing as the line size increases	
PIPE SIZE RANGE	Standard Sensor: 3"-72" Nominal Diameter Small Pipe Sensor: 1.25"-2.5" Nominal Diameter	
INPUT POWER	22 - 26 VDC with maximum power draw at 25 Watts 20 - 28 VAC with maximum power draw at 30 VA, 50/60 Hz	
I/O SIGNALS	Two (2) Analog Outputs. Active 4-20mA, 0-10V, or 0-5V Two (2) Analog Inputs. Passive 4-20mA Two (2) 1000ohms RTD Inputs Three (3) Digital Inputs/Outputs (Field Selectable) One (1) Frequency Output (0-15V peak pulse, 0-1000hz)	
ELECTRONIC ENCLOSURE	FLOW SENSOR RATING	NEMA 6
	REMOTE MOUNT DISPLAY RATING	NEMA 4
	MOUNTING OPTION	Remote mount with kit, up to 200ft.
	DISPLAY	4.3 inch touch screen display. Resolution of 480x272 pixels
MATERIAL	REMOTE MOUNT DISPLAY	Powder Coated Die Cast Aluminum
	FLOW SENSOR	Wetted metal components: 316 Stainless Steel
		Sensor head: XAREC
FACTORY PROVIDED CABLE (SENSOR TO REMOTE DISPLAY)	Up to 200' of three twisted pairs, 22 gauge conductors with individual shields, PVC jacketed, suitable for direct burial with ½" NPT conduit connections or strain relief fitting.	
PROGRAMMING	AVAILABLE OPTIONS	Menu-driven user interface via touchscreen PC user interface via micro USB and downloadable software
ELECTRICAL CONNECTIONS	INPUT POWER	Removable orange terminal blocks for use with 18-22 AWG
	I/O SIGNALS	Removable green terminal blocks for use with 18-22 AWG
	RS485	Removable green terminal blocks for use with 18-22 AWG
	IP	RJ45 connector
COMMUNICATION PROTOCOLS	BACnet MS/TP, BACnet UDP/IP, MODBUS RTU, MODBUS TCP/IP	

*Specifications subject to change without notice.

1.3 STANDARD FEATURES AND SPECIFICATIONS (Continued)

NETWORK CONFIGURATION & ADDRESSING	BACnet MS/TP	BAUD RATES: 9600, 19200, 38400, 57600, or 76800 (Default: 38400) Device Address Range: 1 – 127 (Default:017) Device Instance Range: 1 – 4,194,302 (Default:57017) Max master: 1-127
	BACnet UDP/IP	IPV4 Address: Programmable (Default:192.168.1.24) Instance Number: 1 – 4,194,302 (Default: 57017) Subnet Mask: Programmable (Default:255.255.255.0) Gateway Address: Programmable UDP port: Programmable (Default:47808) DHCP Available
	MODBUS RTU	MODBUS Address Range: 1- 247 (Default: 017) BAUD RATES: 9600, 19200, 38400, 57600, or 76800 (Default: 38400) Data format: 8 bit Stop bits: 1 Parity: None, Odd, or Even (Default: None) Byte Order: ABCD
	MODBUS TCP/IP	IPV4 Address: Programmable (Default:192.168.1.24) Subnet Mask: Programmable (Default:255.255.255.0) Gateway Address: Programmable Port: Programmable (Default:502) DHCP available
APPROVALS	CE	IEC 61000-6-2 Power-Frequency Magnetic Field, Radiated Immunity and Electrostatic Discharge
		IEC 61000-6-4 Radiated Emissions
		EN 301 489-17 Radiated Emission, RF Immunity, and Electrostatic Discharge
		EN 301 328 Wideband transmission systems
	UL	UL 50: Standard for Enclosures for Electrical Equipment
UL ANSI/NSF 61 & 372 Drinking Water Safety (SENSOR ONLY)		
UL 61010-1 Safety Requirements for Electrical Equipment for Measurement, Control, and Laboratory Use		
FCC: Part 15, Subpart B		

1.4 ADDITIONAL REQUIRED HARDWARE

All ONICON insertion type meters can be installed and removed via a 1" or larger full port ball valve without system shutdown. The terms "Standard" and "Hot Tap" refer to the installation method of the isolation valve kit only.

Standard Installation Hardware: For new construction or scheduled shutdown; once kit is installed, the flow meter can be installed or removed without system shutdown.

Hot Tap Installation Hardware: For applications which require the access hole in the pipe to be drilled through the valve using a wet tap drilling machine while the hydronic system is pressurized and operating.

NOTE: Installation hardware materials vary greatly based on pipe material, pipe size and standard vs. hot tap versions.

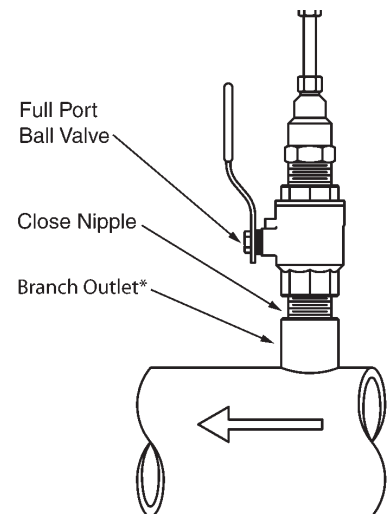

*Weld-on fitting, copper tee or saddle

1.5 ADDITIONAL HARDWARE THAT MAY BE REQUIRED

1.5.1 Grounding Rings

(See next section for hot tap grounding probes - for use in existing pressurized non-metallic piping systems.)

Grounding rings may be required whenever meters are installed in non-metallic or lined pipes. Grounding rings placed before and after the meter eliminate electrical noise that will interfere with the proper operation of the meter. ONICON provides grounding rings as an optional accessory. Grounding ring dimensional information and part numbers are listed below. For proper operation, grounding rings are required before and after the meter.

Typical Installation
Non-conductive Pipe

Note: Refer to page 21 for best earth-ground connection

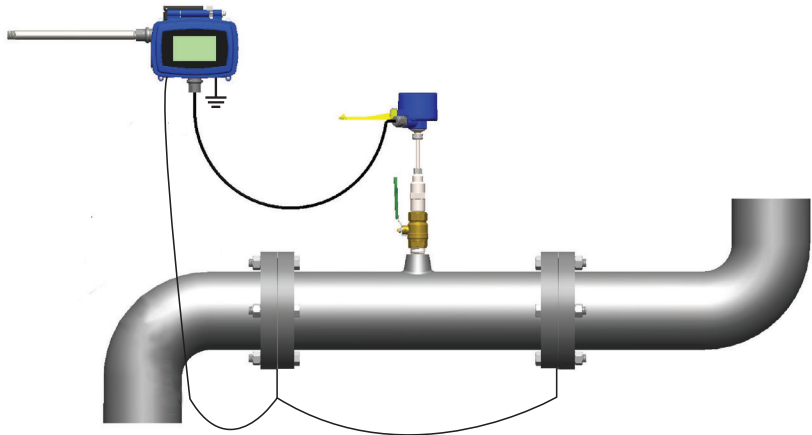

GROUNDING RING DIMENSIONS

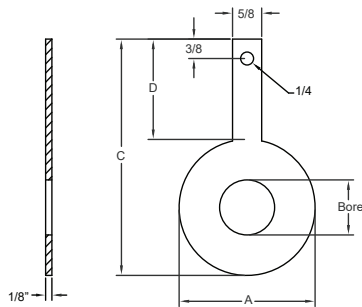

Grounding Ring Dimensions				
Nominal Size	Bore	A	C	D
1.5"	1 - 9/16	3 - 3/8	5 - 5/16	1 - 15/16
2"	2 - 1/16	4 - 1/8	6 - 1/16	1 - 15/16
3"	3 - 1/16	5 - 3/8	7 - 5/16	1 - 15/16
4"	4 - 1/16	6 - 7/8	8 - 13/16	1 - 15/16
6"	6	8 - 3/4	10 - 11/16	1 - 15/16
8"	8	11	12 - 15/16	1 - 15/16
10"	9 - 1/2	13 - 3/8	15 - 5/8	2 - 1/4
12"	11 - 9/16	16 - 1/8	18 - 9/16	2 - 7/16
14"	13 - 1/2	17 - 3/4	20 - 3/8	2 - 5/8
16"	15 - 1/4	20 - 1/4	22 - 7/8	2 - 5/8
18"	17 - 3/8	21 - 5/8	24 - 1/4	2 - 5/8
20"	19	23 - 7/8	26 - 11/16	2 - 13/16
24"	23	28 - 1/4	31 - 1/8	2 - 7/8
30"	29	34 - 3/4	38	3 - 1/2
36"	35	41 - 1/4	45 - 1/4	4
42"	41	48	52 - 1/2	4 - 1/2

GROUNDING RING ORDERING INFORMATION

ANSI Class 150 316 Stainless Steel Grounding Rings (pair)	
Nominal Size	ONICON Part Number
1.5"	19266
2"	19267
3"	19268
4"	19269
6"	19270
8"	19271
10"	19272
12"	19273
14"	19274
16"	19275
18"	19276
20"	19277
24"	19278
30"	19279
36"	19280
42"	19281

1.5.2 Grounding Probes

Grounding probes may be required whenever meters are installed in pressurized systems with non-metallic or lined pipes. Grounding probes can be hot-taped to avoid draining the system. A grounding probe is required before and after the meter to ground any electrical noise coming from any direction.

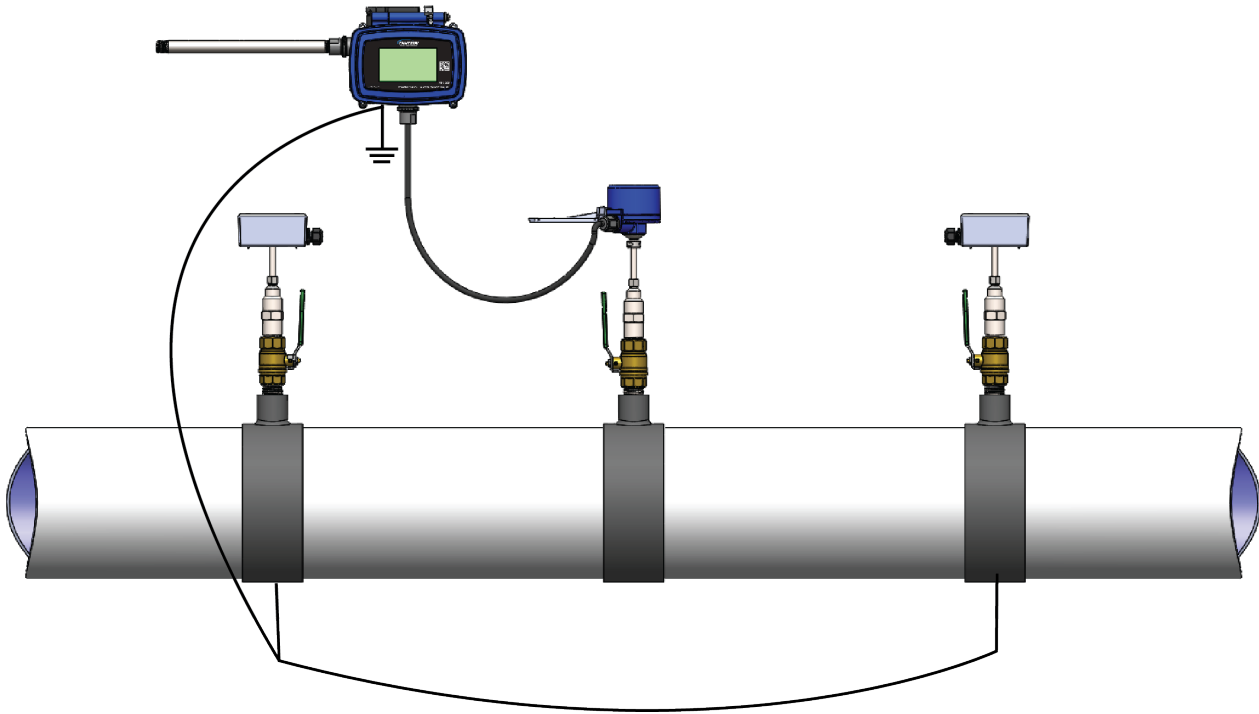

1.5.3 The Temperature Sensors

The two temperature sensors must be located in such a manner as to accurately measure only the temperature of the supply line entering and the return line leaving the portion of the piping system for which the energy measurement is being made.

If possible, find an easily accessible location where wire connections can be made from floor level. This will facilitate any future service. Place the temperature sensors away from strong sources of electrical noise that might affect the performance of the sensors.

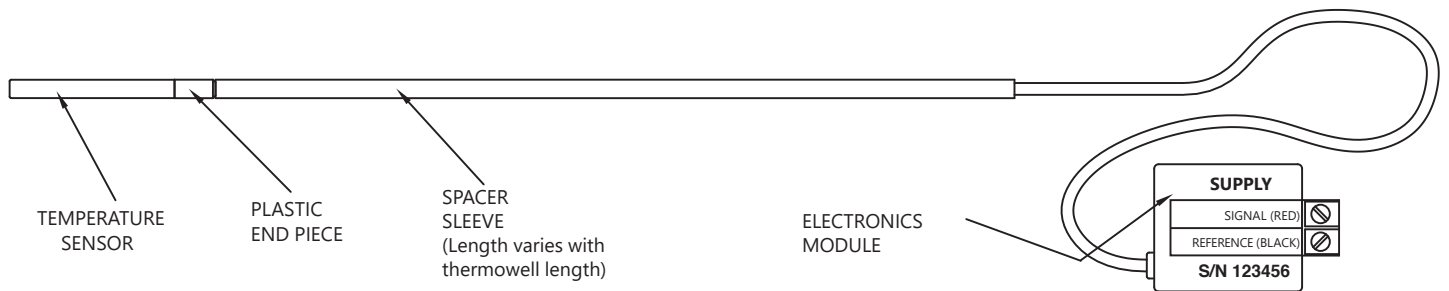

One temperature sensor thermowell will need to be placed in the same pipe with the flow meter. It should be located on the downstream side of the flow meter. The downstream distance between the thermowell and flow meter should be at least five pipe diameters, leaving enough clearance to remove either sensor from the pipe without interference from the other sensor.

1.5.4 Thermowell Installation

IMPORTANT NOTE

It is important that no dirt or other foreign material be allowed into the thermowells as this could affect the thermal response of the system.

1.5.4.1 Dry Tap Thermowells

Dry tap thermowells are for new construction or scheduled shutdown. The most common installation methods are shown below. Refer to Appendix A-1 for thermal insulator installations and Appendix A-2 for high temperature (>300°F) thermowell installations. Consult ONICON for special applications.

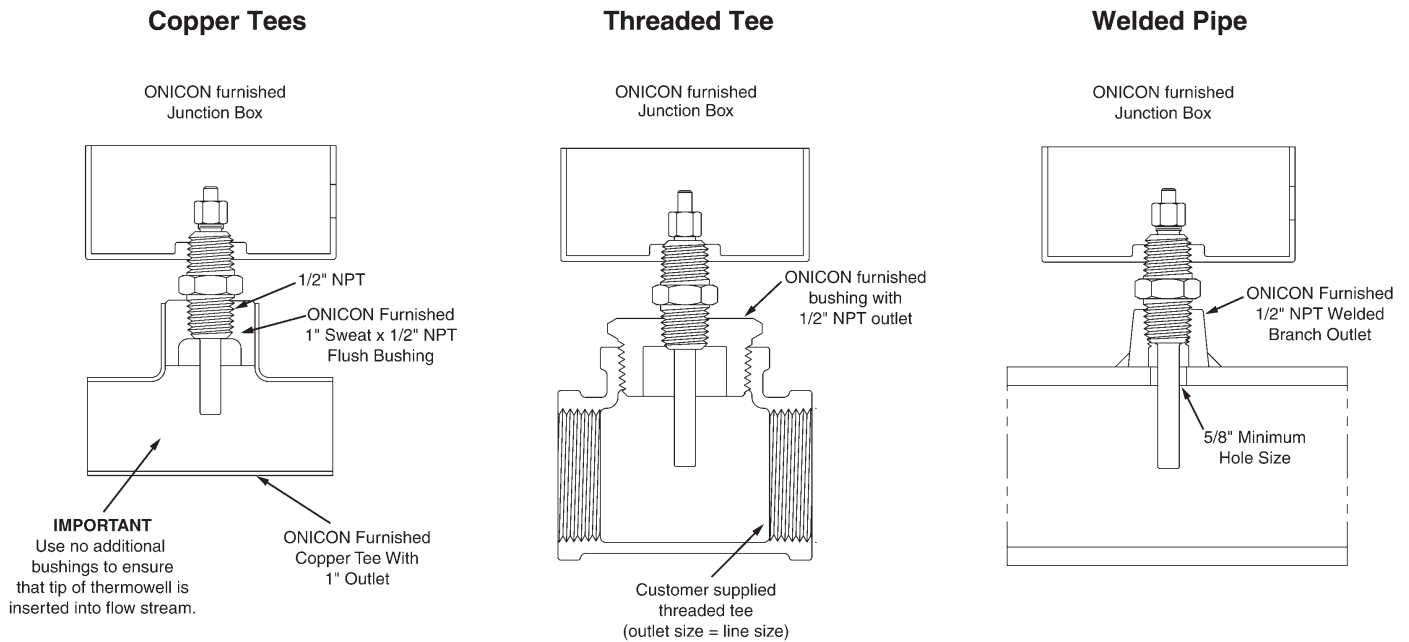

NOTES

1. Thermowell length varies with pipe size.
2. If additional fittings are required, ensure that tip of thermowell is inserted into flow stream.

1.5.4.2 Hot Tap Thermowells

Hot tap thermowells are designed for retrofit applications where it is not practical to isolate and drain the pipe section prior to installation. The thermowell is installed through a 1" full port ball valve as shown in the drawing on the next page. A hot tap drilling machine equipped with a 7/8" drill is required to perform this type of installation.

Install the valve assembly as shown in the drawing and then drill the 7/8" hole using the hot tap drilling machine. Once the valve assembly has been installed and the hole has been drilled, the thermowell can be inserted into the flow stream without a system shutdown.

1.5.4.2 Hot Tap Thermowells (CONTINUED)

WARNING

SYSTEM MAY BE UNDER HIGH PRESSURE. Be sure to hold the conduit box firmly by hand before slowly loosening the position clamping nut when installing, adjusting or removing the thermowell. Failure to do this will allow the pressure to suddenly and rapidly force the thermowell from the pipe, potentially causing serious injury. The thermowell could also be damaged or break apart causing a break in the water seal with the resultant loss of large amounts of water.

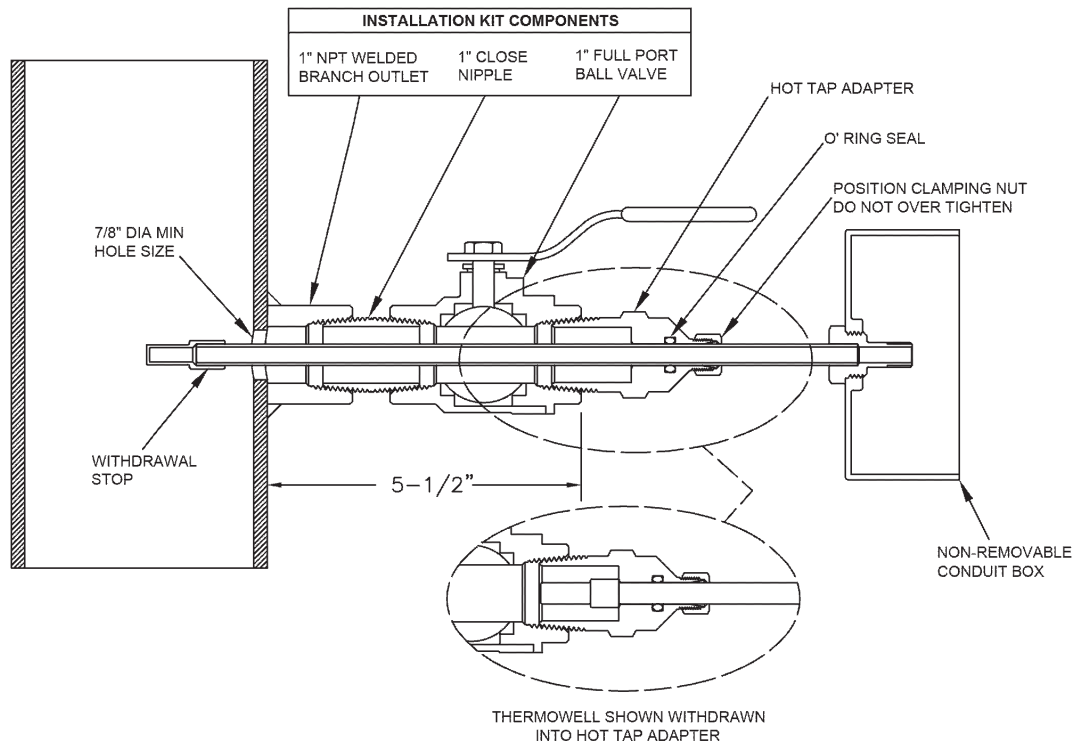

Hot Tap Installation Detail For Thermowell In Welded Pipe

Insertion of the Hot Tap Thermowell

1. Calculate the insertion force (lbs) required by multiplying the system pressure (psig) by 0.11. The person inserting the thermowell should ensure adequate footing for the force required prior to opening the valve.
2. Thread the hot tap adapter into the valve. Firmly grasp the wiring enclosure, loosen the position clamping nut, open the valve, and carefully push the thermowell into the flow stream. Use the attached gage to set the insertion depth.
3. Carefully tighten the position clamping nut that is located at the top of the 1" NPT hot tap adapter fitting. Do not release the wiring enclosure until the position clamping nut has been tightened.

CAUTION

Excessive vibration can damage the thermowell. Insert the thermowell to the proper depth using gauge supplied as shown. Reduce the insertion depth as necessary if strong vibrations are felt during insertion, making certain that the tip of the thermowell remains fully in the flow stream.

CAUTION

DO NOT OVER TIGHTEN THE POSITION CLAMPING NUT. If fluid leaks, do not attempt to correct by tightening this nut further. An internal o-ring seals the fluid. Contact ONICON for assistance in the event of a leak.

Removal Of The Hot Tap Thermowell

WARNING

Maintain a firm hold on the wiring enclosure until the thermowell is completely withdrawn and the valve is closed.

1. System pressure will try to push the thermowell out of the flow stream when the clamping nut is released. Be sure to establish safe footing prior to loosening the clamping nut. The force pushing out against the thermowell is the same as the insertion force calculated above.
2. Grasp the wiring enclosure firmly, holding the thermowell in the pipe and then loosen the position clamping nut. Slowly withdraw the thermowell from the pipe. After the thermowell is completely withdrawn, carefully close the isolation valve.

IMPORTANT NOTE

Rotating the thermowell as you slowly withdraw it through the valve will ensure that the lower tip is fully withdrawn and completely free of the valve. If resistance is felt when closing the valve, open valve fully and rotate the well as you pull it further out of the pipe.

1.5.5 Thermowells for 4-wire RTDs

1.5.5.1 5mm Diameter Thermowell

5 mm RTDs are provided with thermowells with 1/2" male NPT process connections. They are designed for use in 1/2" to 2 1/2" line size tees provided by the customer. The RTDs are push-in type and are held in place with a set screw. Depending on the pipe material, the kit may include a copper sweat bushing or a threaded reducer bushing.

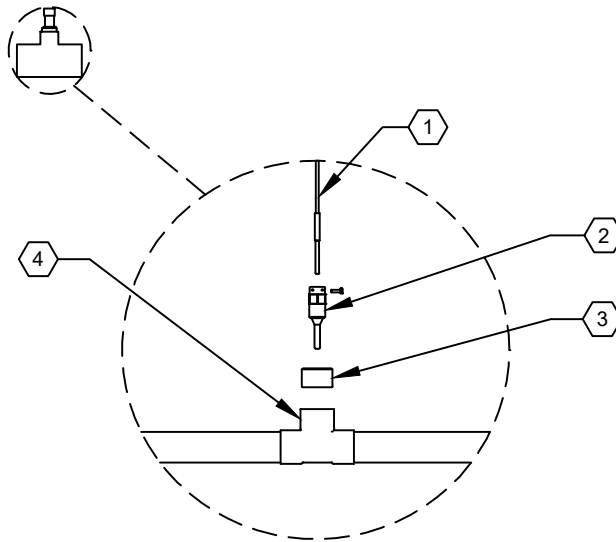

1. RTD temperature sensor – provided by ONICON.
2. 5 mm diameter thermowell – provided by ONICON.
3. 1" solder x 1/2" NPT bushing OR line size x 1/2" bushing – provided by customer or ordered from ONICON.
4. Customer supplied line size tee.

1.5.5.2 6mm Diameter Thermowell

6mm RTDs are provided with matching length thermowells with 1/2" male NPT process connections. They are designed for use in 3" and larger diameter pipes. The RTDs are push-in type and are held in place with a set screw. The kit includes two (2) weld-on branch outlets with 1/2" NPT threads.

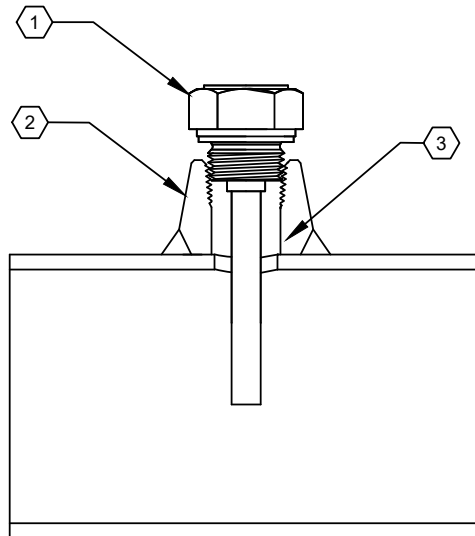

1. 6 mm diameter thermowell - provided by ONICON.
2. 1/2" NPT weld on branch outlet - provided by ONICON.
3. 3/4" minimum hole size.

SECTION 2.0: UNPACKING

The FT-3500 sensor, remote display, and cable will be packed together in one box. All other installation hardware and peripheral devices will be packaged and shipped separately.

IMPORTANT NOTE: Sensor and Remote Display are calibrated together and matched by serial number.

Please open all packages with care to prevent damage to their contents. Carefully inspect each item for signs of damage in transit. The flow meter stem should be straight and free of blemishes or abrasions. The sensor head should have a smooth continuous surface that is free of abrasions.

All ONICON products are shipped insured unless the customer specifically requests otherwise. Please notify the shipping company and ONICON immediately if any items are damaged in transit. Save all packing material for inspection by the shipper.

2.1 CHECKING THAT YOU HAVE RECEIVED EVERYTHING

- Quick Start Guide and Meter Configuration (hanging tag)
- Flow Meter Certificate of Calibration
- Transmitter Quick Start Guide
- Configuration Sheet
- FT-3500 Insertion Electromagnetic Flow Meter
- Adjustable Insertion Depth Gauge
- Installation Hardware Kit, if ordered. (separate box)

Please notify ONICON if any of the documents or meter components are missing.

If boxes were damaged in transit, please take photos immediately upon arrival, before unpacking the meters. Then, also take photos of any obvious product damage and send all photos to CustomerService@onicon.com.

SECTION 3.0: INSTALLATION, REMOVAL AND ADJUSTMENT

WARNING

Insertion flow meters may be installed in pipes which are under high pressure. Accidents with these systems can cause serious injury or death. Only persons experienced with high pressure systems and related knowledge in the heating, cooling and fluid metering fields should attempt to install, adjust, or remove the flow meter. Please read all instructions before attempting to insert or remove a flow meter.

ONICON will be happy to assist with technical recommendations and to provide guidance by telephone (727-447-6140) or e-mail (techsupport@onicon.com). On-site field engineering, installation and service is also available at additional cost.

3.1 INSTALLATION SITE SELECTION

Install the flow meter where it will be accessible for personnel to perform necessary periodic maintenance. The clearance required for installation is typically 30-40" from the pipe wall to the nearest obstruction above the valve assembly. This clearance dimension will increase with large diameter pipes. The environment should be free of corrosive liquids/fumes, temperature extremes and heavy vibration. The following diagrams should be used as a guide to the proper location for installing the meter.

GENERAL PRACTICES:

1. For best results, install the flow meter in a straight run of pipe, free of bends, tees, valves, transitions, and obstructions.
2. Straight run requirements vary based on the nature of the upstream obstruction.
See the table on the following page for guidelines in determining minimum up stream straight run requirements based on the nature of the obstruction.

Note: Depending upon specific location details, more or less straight run may be required to produce a satisfactory flow profile.

3. If there is insufficient straight run, allow 80% of the run upstream and 20% of the run downstream. If the total length of straight run is less than 70% of the recommended length, performance may seriously degrade, and consideration should be given to changing to the FT-3000 Series Inline Electromagnetic Flow Meter.

How To Determine The Available Straight Pipe Diameters:

For each application, locate the longest straight, unobstructed section of pipe (no bends, tees, valves, other insertion probes, size transitions). The longest straight pipe run in inches divided by nominal pipe size in inches equals "diameters of straight pipe." For closed loop applications, consider both the supply and return lines as possible locations.

IMPORTANT NOTE

Always use the maximum available straight run. When more than the minimum required straight run is available, place the meter such that the excess straight run is upstream of the meter location.

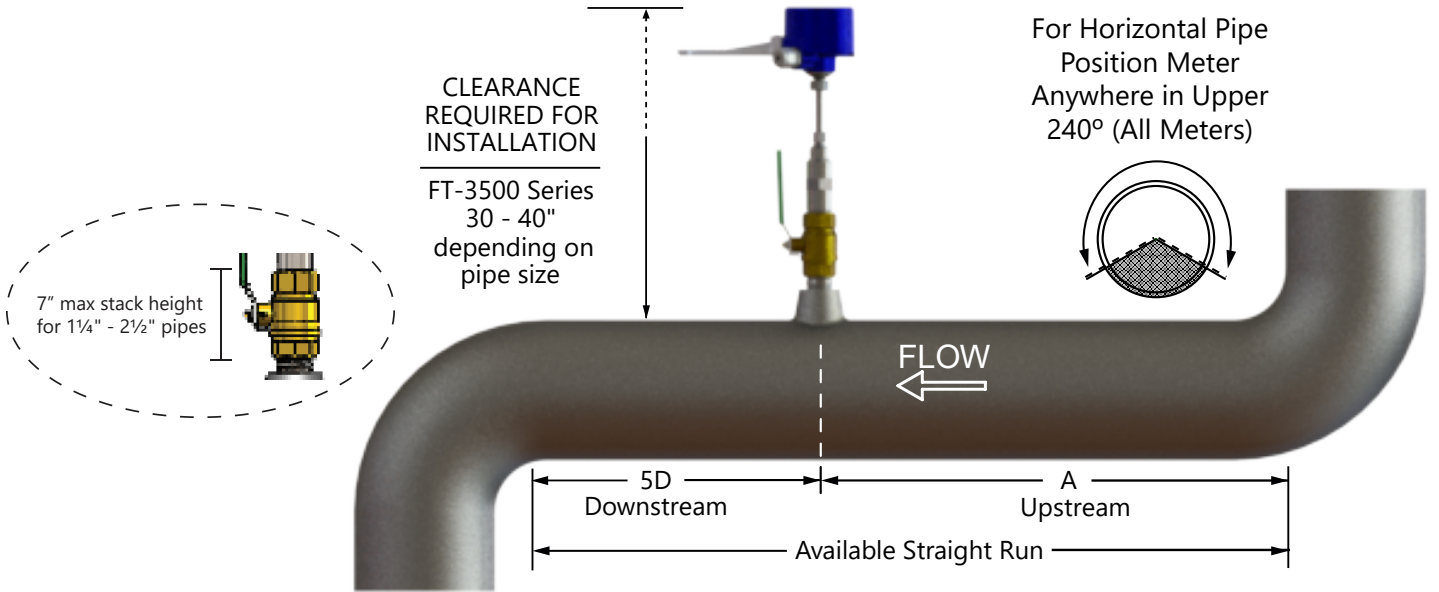

Upstream obstruction	(A) Minimum straight run required upstream of meter location
Single bend preceded by ≥ 9 diameters of straight pipe	10 Diameters
Pipe size reduction / expansion in straight pipe run	10 Diameters
Single bend preceded by ≤ 9 diameters of straight pipe	15 Diameters
Outflowing tee / Pump outflow	20 Diameters
Multiple bends out of plane	30 Diameters
Inflowing tee	30 Diameters
Control / Modulating valve	30 Diameters

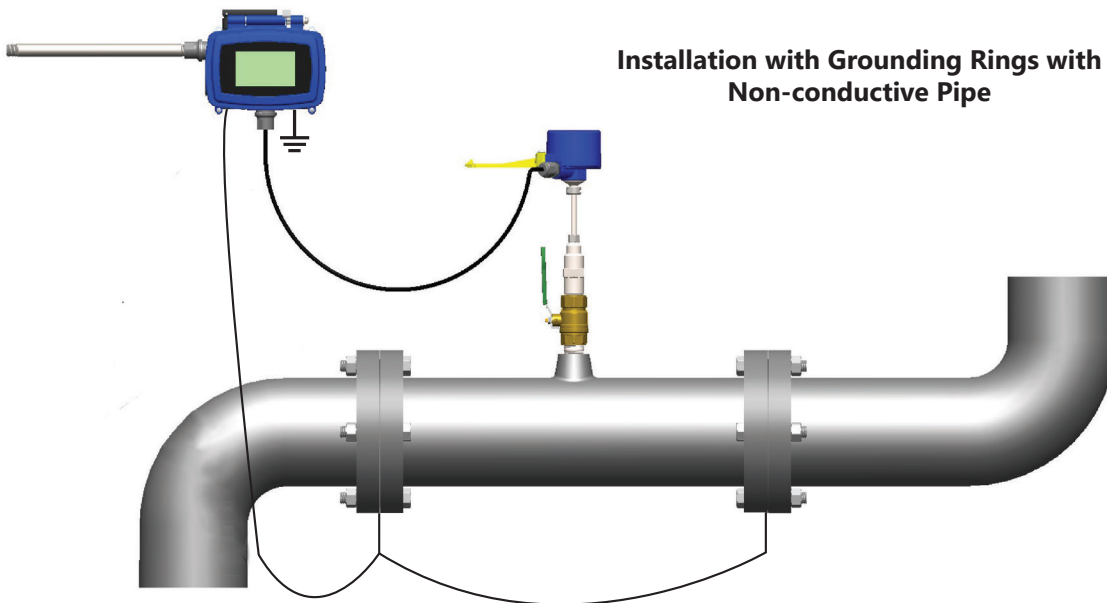

Additional straight run may be required upstream of the upstream grounding ring based on the nature of the upstream obstruction. Refer to the chart above to determine how much straight run is required.

3.2 MECHANICAL INSTALLATION

ONICON Insertion Electromagnetic Flow Meters employ a hot tap adapter design that allows for insertion and removal, when necessary, without interrupting flow and draining the pipe. To take advantage of this feature, the flow meter must be installed through an isolation valve. The installation must allow for sufficient clearance to fully extract the meter, and a full 1" opening in the pipe wall is required to clear the sensor head and allow for insertion. Make sure that your valves and fittings are full port and at least 1" in actual internal diameter.

NOTE: For pipe sizes 1¼" to 2½", the max stack height is 7".

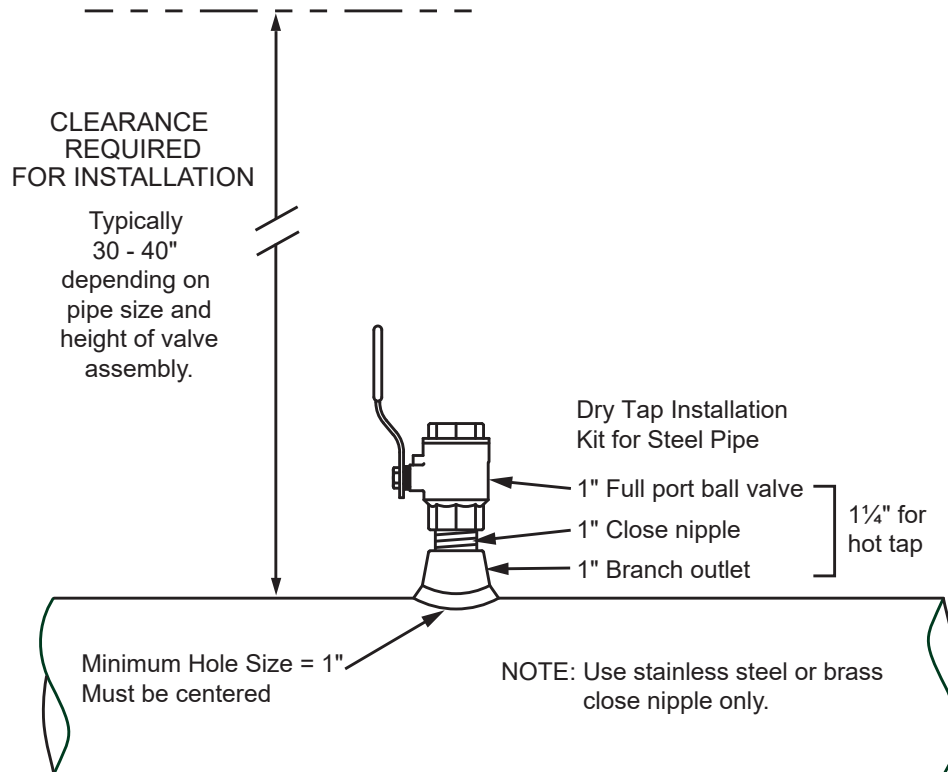

CAUTION

ONICON insertion style flow meters must be installed through a valve assembly. Failure to do so negates the ability to remove the meter without shutting down and draining the system. It will also result in an excessive amount of stem protruding from the pipe. Excessive stem lengths unnecessarily expose the meter to incidental damage.

IMPORTANT NOTE

Flow meters installed through oversized access holes will be subjected to undesirable turbulence that may affect the accuracy of the meter.

3.2.1 Installation Kit

ONICON offers a wide range of installation hardware kits for commonly used pipe materials. The kits are specifically designed for ONICON flow meters, and their use is recommended.

The use of ONICON installation hardware kits accomplishes two important objectives. First, it ensures that the proper hardware is used. Second, it simplifies order processing by standardizing the dimensions of the installation hardware. ONICON must have an accurate measurement of the overall height of the installation hardware as measured from the outside wall of the pipe to the top of the valve in order to determine the correct stem length when assembling the meter in our factory. ONICON documents refer to this dimension as the stack height

ONICON installation hardware kits consist of three separate component parts:

Some type of threaded stainless steel or brass branch outlet,



An interconnecting stainless steel or brass close nipple,



And a full port isolation stainless steel or brass valve.



Different pipe materials require different branch outlets and may include additional bushings to properly size the opening.



ONICON copper tee



3.2.2 ONICON Standard Installation Hardware Kit

Standard installation hardware kits are designed to be installed on piping systems that are drained and at atmospheric pressure. The access hole is drilled (1" minimum) prior to installation of the branch outlet with 1" NPT threads, close nipple and full port ball valve. Once the isolation valve is installed, the piping system can be flushed, filled and pressurized. The flow meter may now be inserted or removed by hand without having to drain the system. Please read all instructions before proceeding with meter insertion.

3.2.3 ONICON Hot Tap Installation Hardware Kit

ONICON offers an alternative installation hardware kit when it is not practical to relieve pressure and drain the system. In this case, a 1 1/4" branch outlet, close nipple and 1 1/4" full port ball valve are installed first. Then, a hot tap drilling apparatus is used to drill a 1" diameter hole through the valve. This eliminates the need to shut down and drain the pipe. Please read all instructions before proceeding with meter insertion.

3.2.4 Customer Supplied Installation Hardware

There are occasions where circumstances require that the customer provide the installation hardware or that the flow meter must be installed through existing hardware. In these cases, it is important to confirm that the installation hardware is suitable for use with the flow meter provided by ONICON before it is installed. The installation must allow for sufficient overhead clearance to fully extract the meter and a full 1" opening in the pipe wall is required to clear the sensor head and allow for insertion. Make sure that your valves and fittings are full port and at least 1" in actual internal diameter.

Installation hardware generally consists of three separate component parts:

Some type of threaded branch outlet,



An interconnecting close nipple,



And a full port isolation valve.

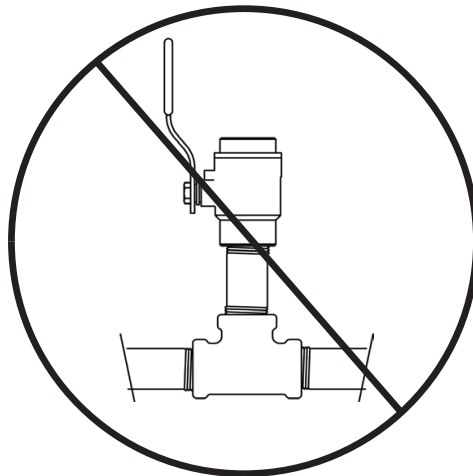

CAUTION

Do not use threaded steel or slip PVC tees to provide the 1" opening in the pipe. Tees of this type will cause significant errors in the flow measurement.

CAUTION



In order to provide the flow meter with the correct stem length, ONICON must know the overall height of the installation hardware as measured from the outside wall of the pipe to the top of the valve where the meter is installed.

CAUTION

Use stainless steel or brass nipple only.

3.2.5 Confirming the Stack Height

ONICON insertion flow meter stem lengths vary according to the pipe diameter and the height of the installation hardware stack. ONICON records the stack height dimension provided by the customer at the time of order entry, and the information is used to size the stem. For standard configuration meters, the dimension of the max stack height and the depth gauge is shown on the tag attached to the meter.

DO NOT REMOVE TAG		
	+1 (727) 447-6140 www.onicon.com	
		
	Meter Tag:	FT - 3400
	Model No:	FT-3400-12-A
	S/N:	1132525
	Max Stack Height	8.625"
	Gage Length:	15.325"
	Pipe Data:	8 inch PVC Schedule 40
	Analog Output Type:	4-20 mA/ 0-5V
	Analog Output Range:	Full Scale
	Max Frequency:	1000
Meter Factor:	45451	
Scaled Pulse Output:	100 Gal/Pulse	
Peripheral Equipment:	-----	
Calibrated By: Sadhu Moka		
Date: September 20, 2023		

Prior to installing the meter, confirm the actual available stack height is less than the max stack height recorded in the meter tag. Flow meter stems are intentionally over sized to allow for variations of at least 2" in the stack height. Small Pipe Configuration (1 1/4" to 2 1/2") meters use an insertion depth collar to properly set the insertion depth. Contact ONICON prior to installation if there is any question regarding stack height or stem length. This way ONICON can offer you credit for your meter if you decide to exchange the meter for one with a different stem length. Returns may be subject to a restocking fee.

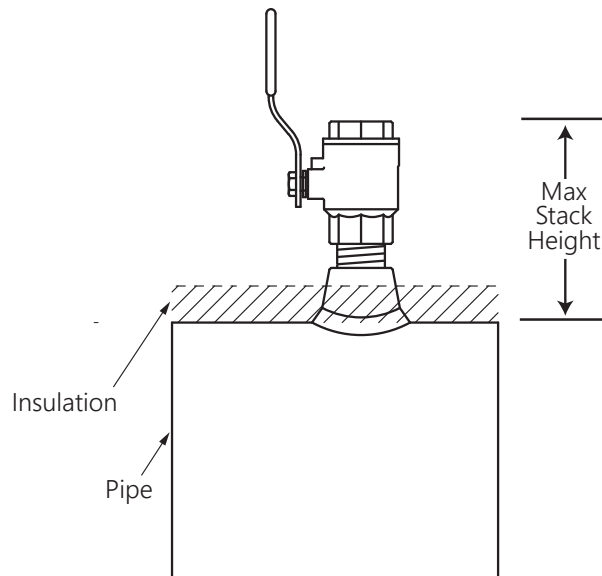

NOTE: For pipe sizes 1¼" to 2½", the max stack height is 7".

Note: A new stem will be needed if the actual stack height is larger than the max stack height. Contact ONICON for support.

3.2.6 Installing Grounding Rings (non-conductive or lined pipes only)

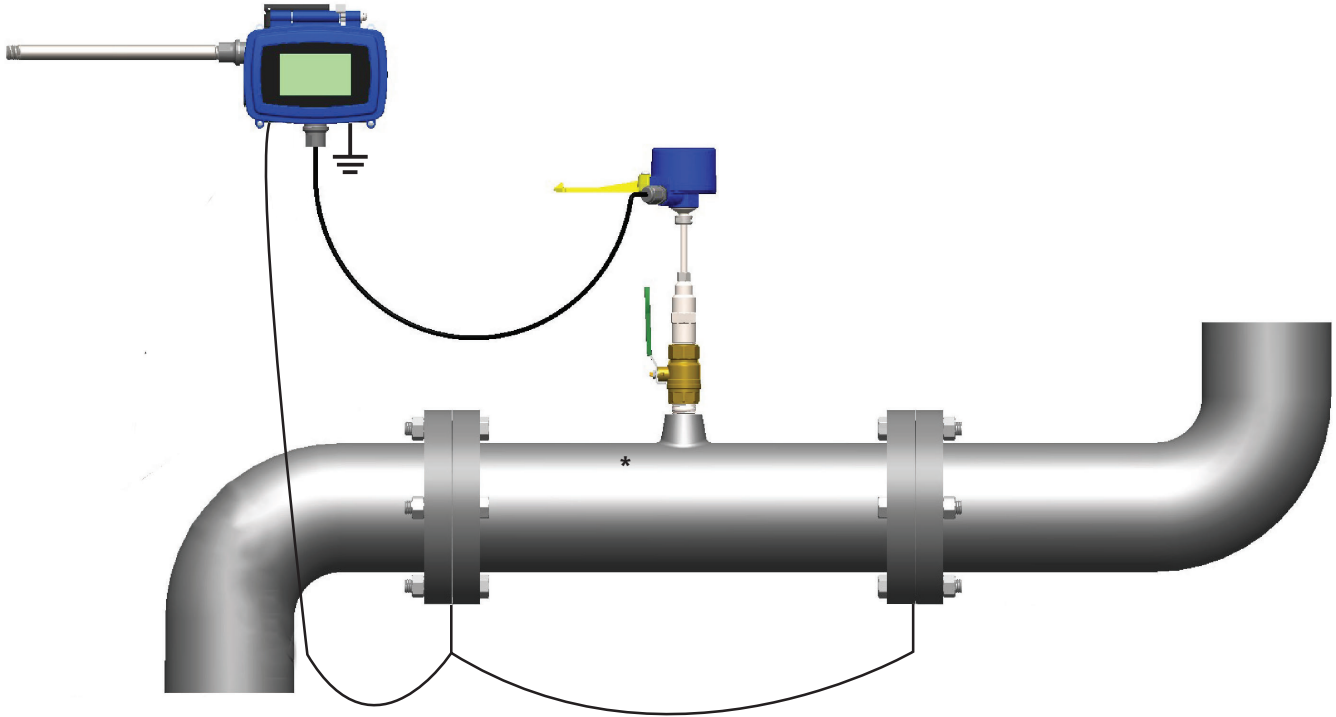

*** Additional straight run may be required upstream of the upstream grounding ring based on the nature of the upstream obstruction. Refer to the chart in Section 3.1 on page 11 of this manual to determine how much straight run is required.**

Grounding rings are used to suppress electrical interference at the installation location for electromagnetic flow meters. They are provided in pairs and are installed upstream and downstream of the flow meter. The use of grounding rings significantly reduces electrical noise and may be necessary for proper operation of flow meters installed in lined or non-conductive pipes.

Installation Instructions

1. Install the rings upstream and downstream of the meter as shown above.
(Please note that the straight run requirements shown above are only for locating the grounding rings with respect to the FT-3500 flow meter. The complete straight run requirements for this meter are found in Section 3.1 on page 15 of this manual.)
2. Install each grounding ring sandwiched between (2) ANSI Class 150 flanges and (2) gaskets.
3. Center each gasket on the grounding ring surface. Do not allow the gasket to protrude into the flow stream.
4. Use the torque specifications provided with the gaskets when tightening the flange bolts.
5. Wire the two grounding rings together as shown and connect them to the flow meter earth wire. Connect this to a known good earth connection. See Section 3.6.1 on page 29 of this manual for additional information on identifying an acceptable earth connection.

3.2.7 Installing the Flow Meter

WARNING

When you are ready to refill the system, make sure that all lines are filled with water before inserting the meter into the flow stream. If the lines are not filled and this is a hot water system, some water may flash to steam and exceed the high temperature limit for the sensor head assembly. This flash over could also exceed the pressure ratings of the meter and the assembly could fail allowing steam and hot water to escape causing serious injury.

Tools needed for standard installation:

- 1 5/16" wrench or adjustable wrench
- 5/8" wrench or small adjustable wrench
- Pipe wrench (to hold valve in place)
- Pipe thread sealant

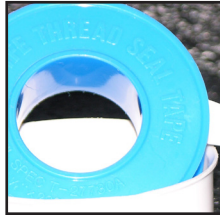

Flush, fill and pressure test the piping system prior to installing the meter. Loosen clamping nut to facilitate installation.

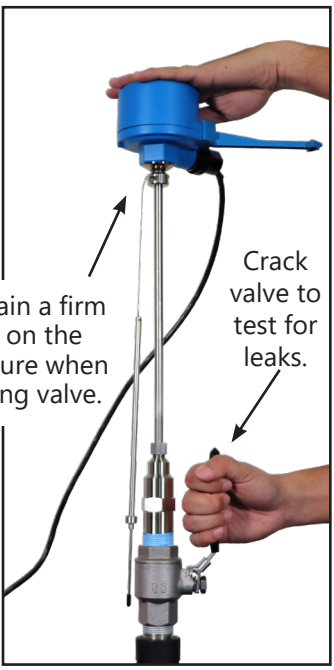
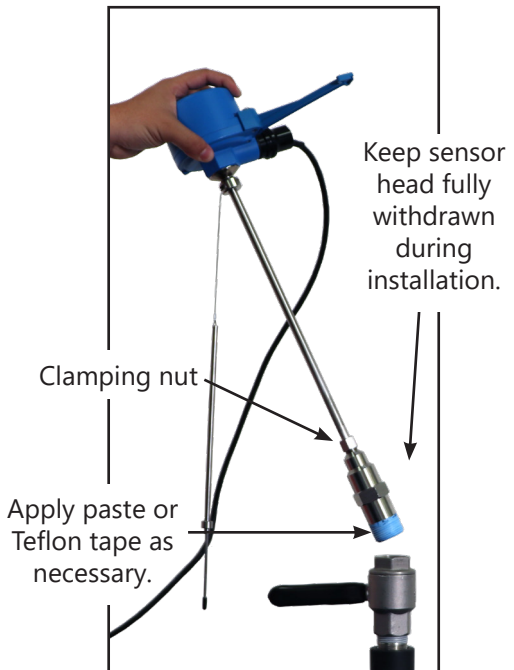

CAUTION

If there are any leaks around the clamping nut or stem, DO NOT ATTEMPT TO STOP THE LEAKAGE BY OVERTIGHTENING THE CLAMPING NUT. Damage to this nut or the clamping ring under the nut may prevent the assembly from properly holding the meter in the pipe. The clamping nut is not part of the sealing mechanism. Any leaks in this area indicate that the "O" ring is not sealing properly and you must contact ONICON for assistance.

3.3 INSERTION OF THE METER

WARNING

SYSTEM MAY BE UNDER HIGH PRESSURE. When adjusting the meter position or removing it, be sure to hold the electronics enclosure firmly by hand before SLOWLY loosening the positioning clamping nut. Failure to do this will allow the pressure to suddenly and rapidly force the meter from the pipe causing serious injury. The meter could also be damaged or break apart causing a break in the water seal with the resultant loss of large amounts of water. The hand effort required to hold the meter will be 0.11 times the pipe pressure.

Begin by calculating the effort that will be required to hold the meter. Establish adequate footing for this task, taking extra caution when working from a ladder or platform. Use the following formula:

$$E = 0.11 \times P \quad \text{Where: } E = \text{effort in pounds} \\ P = \text{system pressure in pounds per square inch}$$

Example: In a 300 PSI system, 33 pounds of effort is required to insert the meter into the pipe.

3.3.1 Inserting Standard Configuration Flow Meters (Pipe Sizes 3" or Larger)

Step 1: Maintain a firm grip on the enclosure to counteract the effects of the pressure in the pipe

Step 2: Slowly open the valve to the full open position.

Step 3: Use the end of the depth gage to pierce any insulation that may be present and rest the gage on the outside wall of the pipe. If unable to pierce the insulation jacket, you will have to adjust depth to account for the insulation thickness.

Step 4: Orient the enclosure so that the alignment arrow is pointing in the direction of flow and is parallel with the pipe.

Step 5: Slowly push down on the flow meter until the bottom of the alignment arrow rests on the top of the depth gauge.

Step 6: Carefully tighten the clamping nut. DO NOT OVERTIGHTEN.

3.3.2 Inserting Small Pipe Flow Meters (1 1/4" -2 1/2")

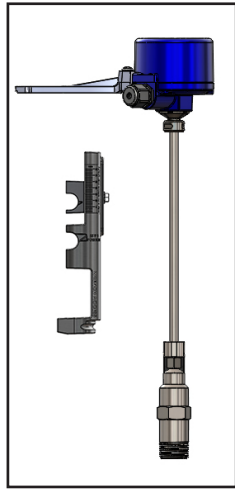

Step 1:
Keep the sensor fully withdrawn during installation.

Step 2:
Apply paste or Teflon tape as necessary.

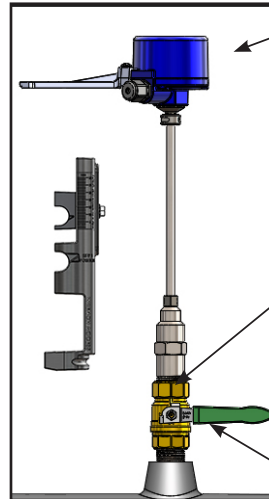

Step 4:
Maintain a firm grip on the enclosure to counteract the effects of the pressure in the pipe.

Step 3:
Thread the hot tap adapter onto the ball valve and tighten it as necessary. DO NOT OVERTIGHTEN.

Step 5:
Slowly open the valve to the fully open position.

Step 7:
Loosen the collar and place it all the way to the bottom.

Step 6:
Loosen the clamping nut.

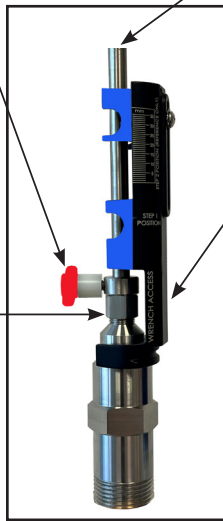

Step 8:
Gently insert the meter until it touches the bottom of the pipe.

Step 9:
Set the depth gauge on the hot tap adapter.

Step 10:
Move the loosened collar to the STEP 1 POSITION marked on the gauge and lock the collar. Make sure the flow direction arrow on the meter enclosure is pointing in the direction of the flow.

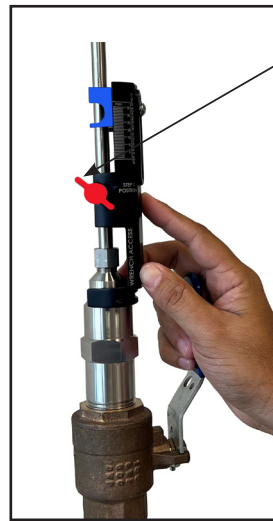

Step 12:
Tighten the clamping nut to set the depth and make sure the flow direction arrow on the meter enclosure is pointing in the direction of the flow.

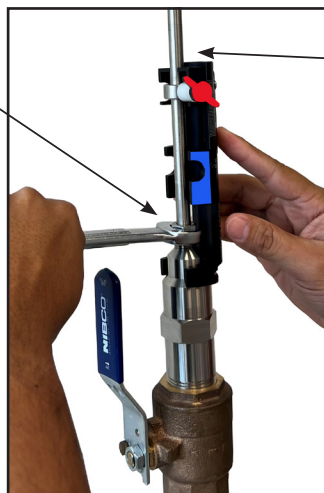

Step 11:
With the collar still locked, rotate the stem and move up to the STEP 2 POSITION.

3.4 REMOVAL OF THE METER

WARNING

SYSTEM MAY BE UNDER HIGH PRESSURE. When removing the flow meter, be sure to hold the electronics enclosure firmly by hand before slowly loosening the positioning clamping nut. Failure to do this will allow the pressure in the pipe to suddenly and rapidly force the meter from the pipe causing serious injury. The meter could also be damaged or break apart causing a break in the water seal with the resultant loss of large amounts of water. The hand effort required to hold the meter will be 0.11 times the pipe pressure.

CAUTION

The main cause of damage to meters comes from accidentally closing the valve on the sensor head. To avoid this, gently rotate the meter by twisting the electronics enclosure back and forth (twist the stem, do not bend it) while you slowly close the valve. If the valve touches any part of the meter, you will feel it as you are twisting the meter. If the valve touches anything, it means the meter is not fully withdrawn. Usually a gentle twisting motion while withdrawing the meter will clear any obstruction and permit the meter to withdraw completely. (Excessive build-up on the stem may require the hot tap "O" ring to be lubricated with silicone.)

WARNING

In hot water systems, even a small amount of water can cause serious personal injury. Use extra caution when working with hot water meters.



Step 1:
Slowly loosen the position clamping nut while maintaining a firm grip on the enclosure to counteract the effect of pressure in the pipe.



Step 2:
Carefully withdraw the flow meter stem from the pipe until the sensor head is fully inside the hot tap adapter.



NOTE:
The hot tap adapter will contain a small amount of water.

Step 3:
After the meter is completely withdrawn, slowly close the valve to isolate flow.

Step 4:
After the valve is completely closed, unscrew the hot tap adapter from the valve. For hot water meters, partially unscrew the adapter to vent pressure before fully removing the meter.

IMPORTANT NOTE

Removal of the meter is the same for small pipe configuration meter installations. The clamping nut can be accessed with the alignment tool installed.

3.5 WIRING CONNECTIONS

3.5.1 Input Power and Sensor Connection

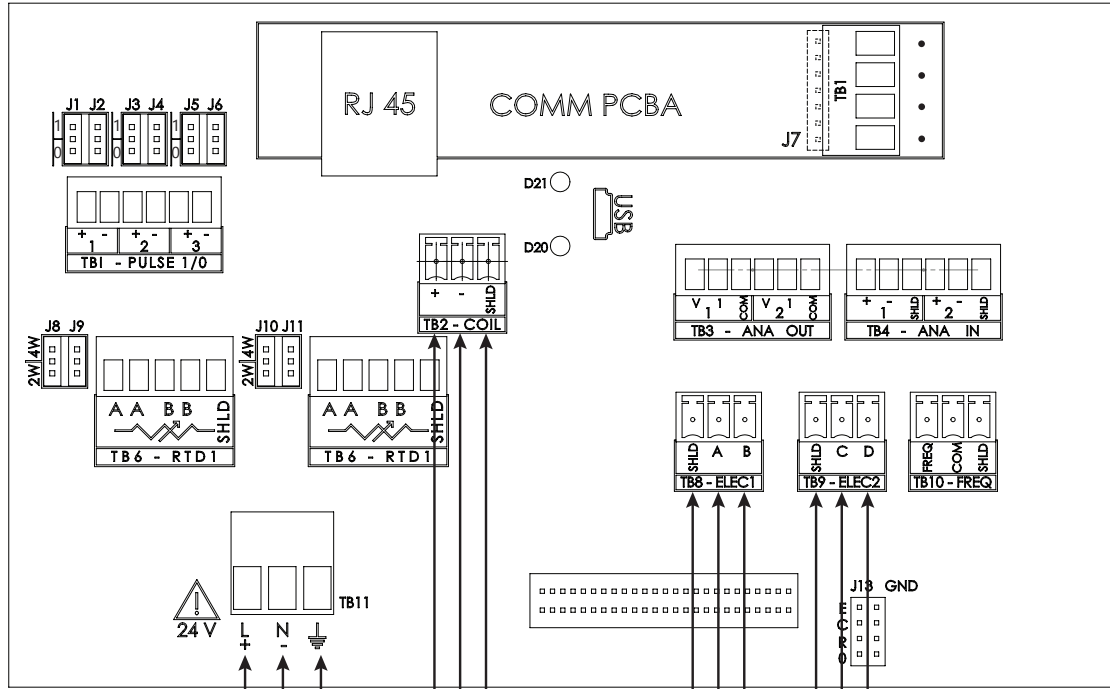

STEP 2

**Input Power
(Class II Power Supply)**

Required
22-26 VDC,
25 W Max
or
20-28 VAC,
30 vA Max, 60 Hz

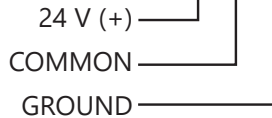

STEP 1

Remote Sensor Connections

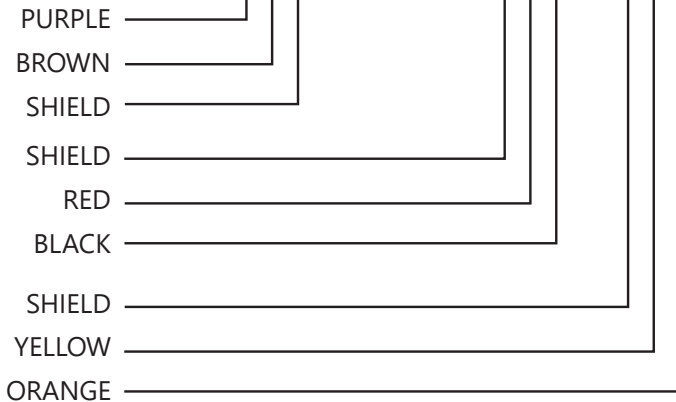

NOTE:
In December 2024/
January 2025, ONICON
produced a cable
variant. If sensor colors
do not match those
listed to the left, please
see Appendix 1 for the
updated wiring table.

3.5.2 Signal Outputs

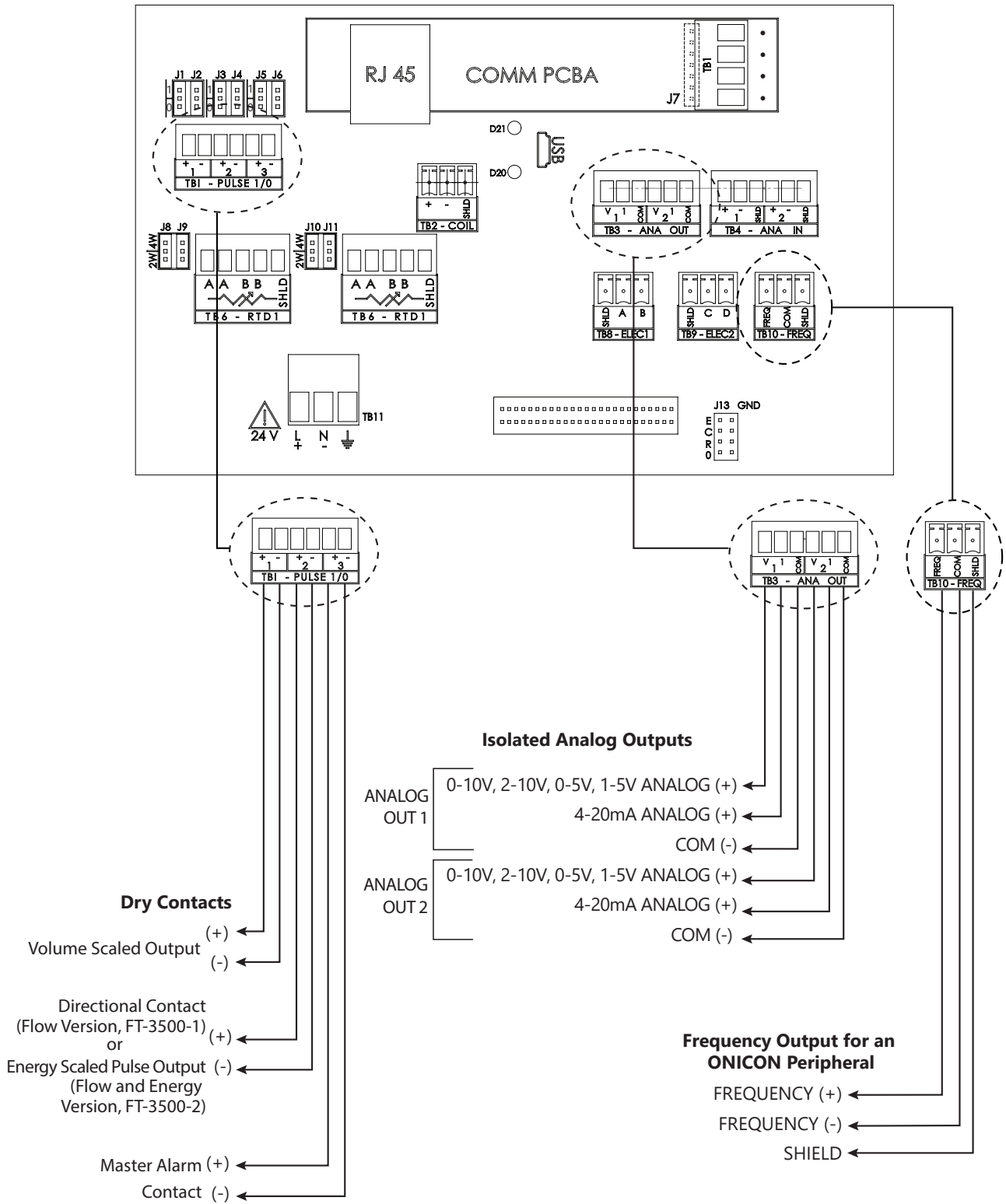

Refer to page 36 to change the configuration outputs if needed.

3.5.3 Temperature Sensor Connection (For Energy Version Only)

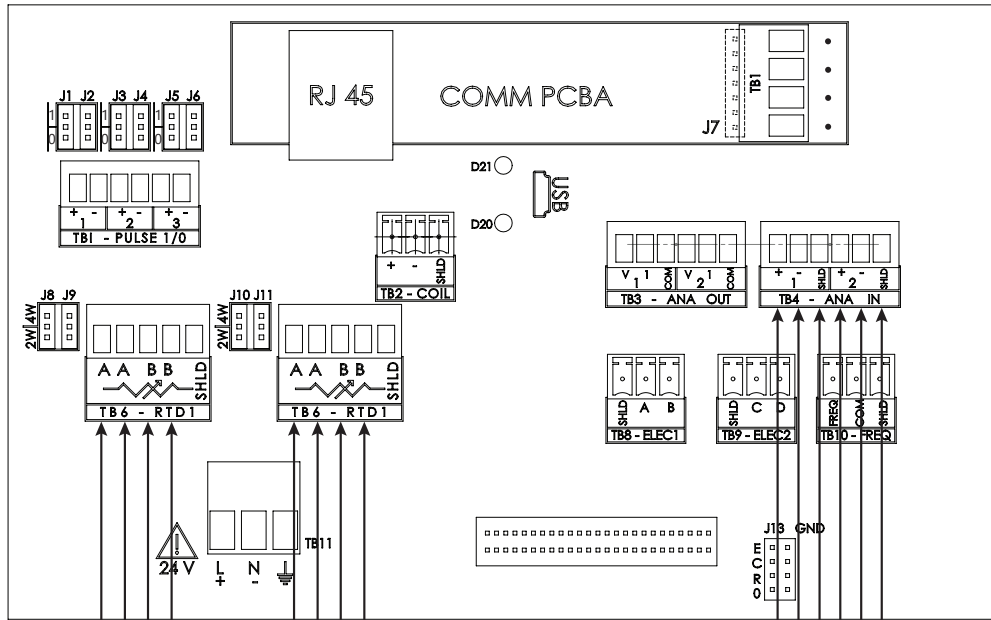

Supply Temperature Sensor

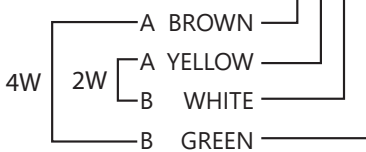

*Move Jumper J8 & J9 for 2W or 4W RTD

Return Temperature Sensor

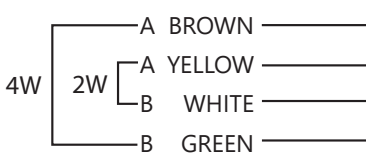

*Move Jumper J10 & J11 for 2W or 4W RTD

OR

Supply Temperature Sensor

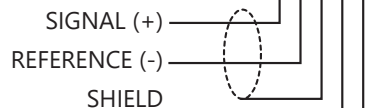

Return Temperature Sensor

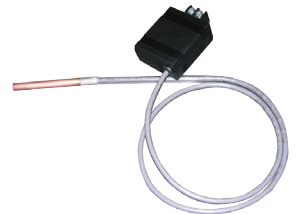
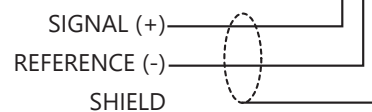

RTD Sensor vs. ONICON Solid State Sensor

NOTE:

Confirm the type of temperature sensor provided. The wiring on the left is for a TSP-RKP-XXXX and the wiring on the right is for TSP-OFR-XXX which is the most common temperature sensor. Refer to the image above to identify the provided temperature sensor.

3.5.4 Network Communications Outputs

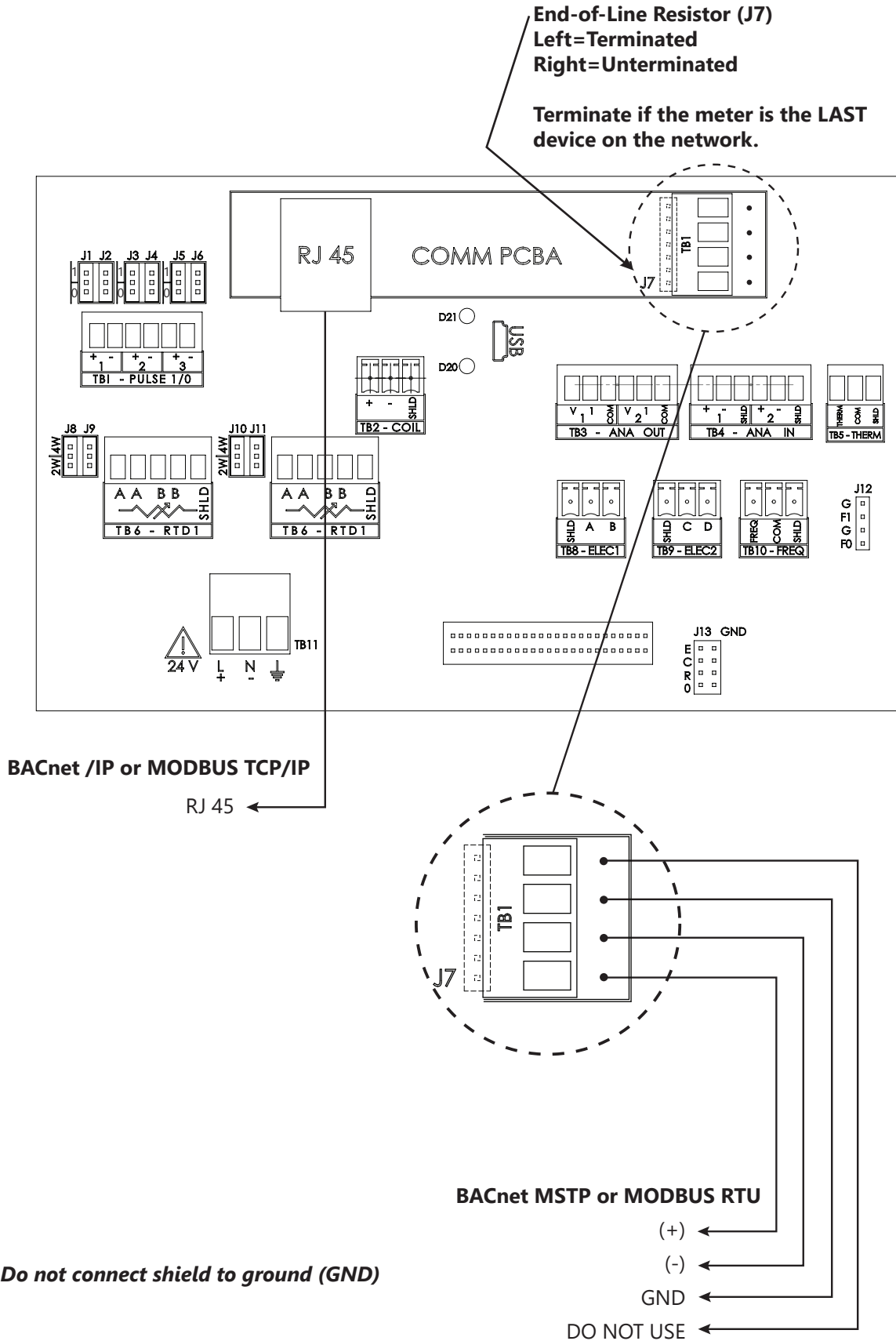

3.5.5 Other Connections

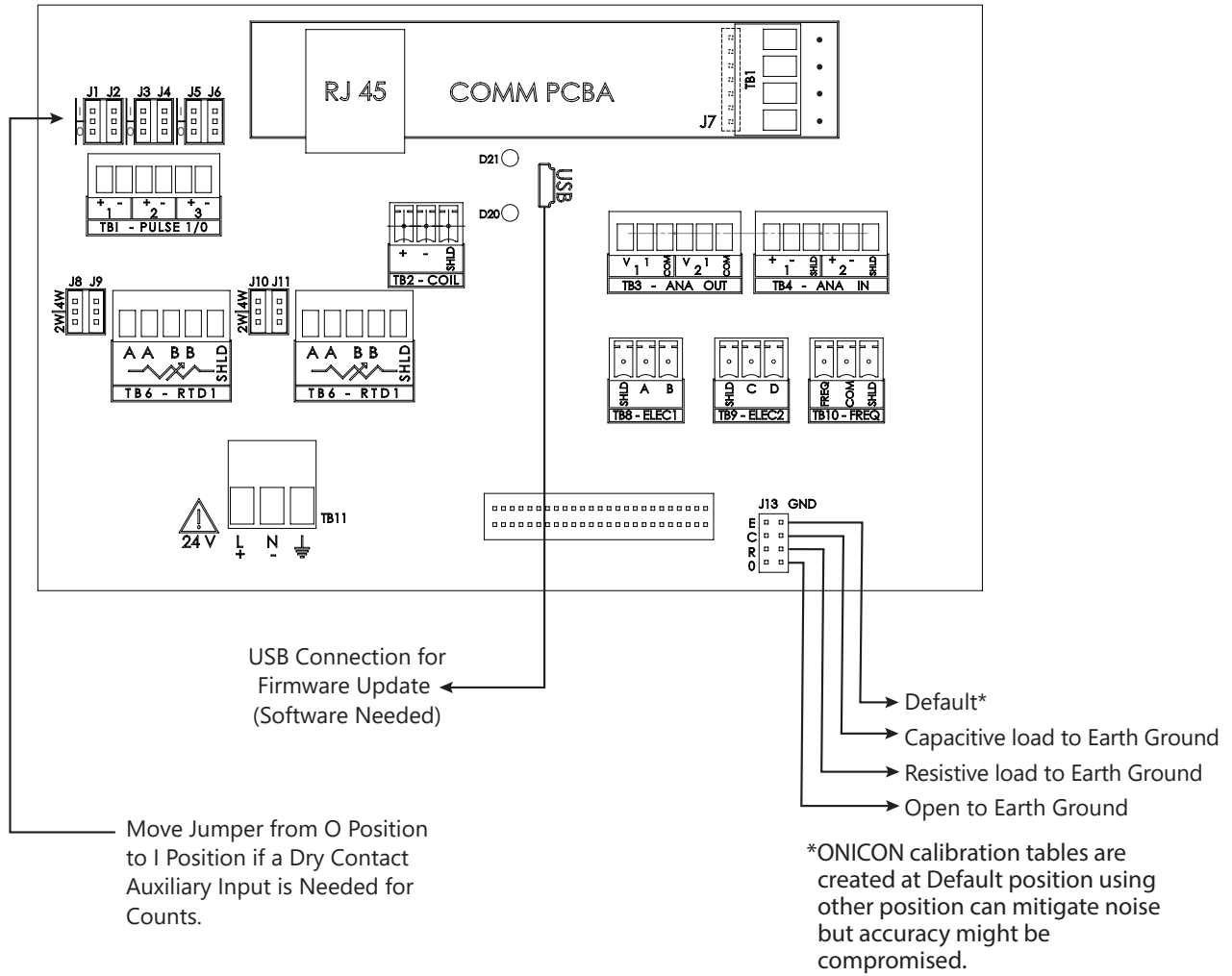

3.6 Signal and Power Wiring Connections

Earth wiring connections for use with grounding rings

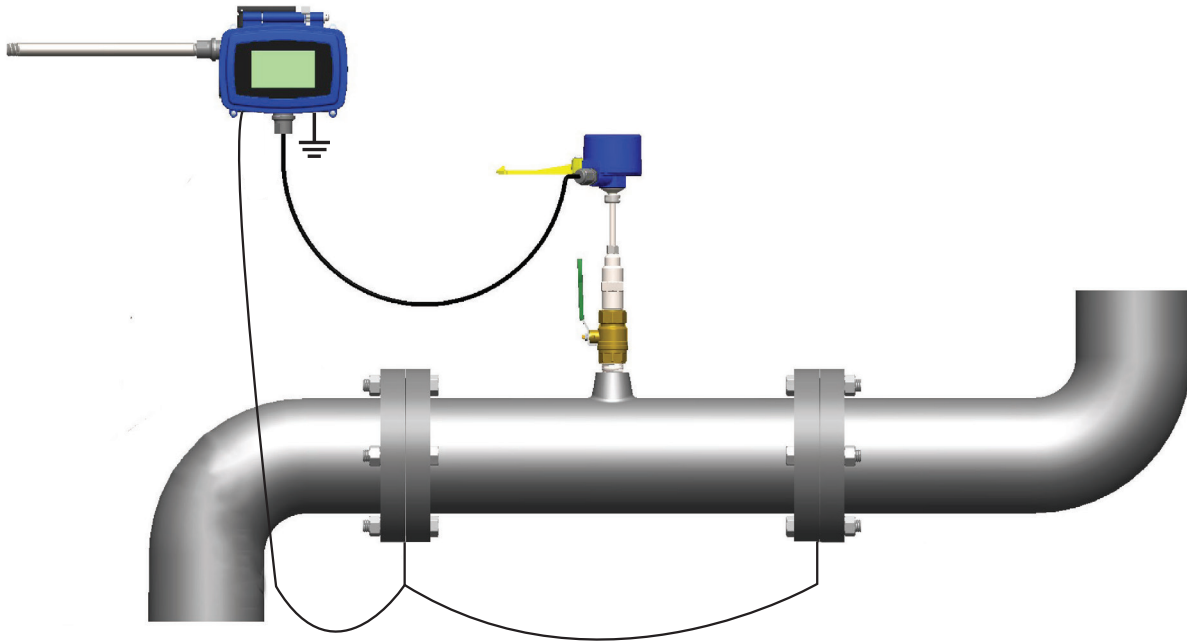

CAUTION

Failure to provide a proper earth connection to the meter may result in excessive electrical noise that will interfere with the operation of the meter.

3.6.1 Earth Connection

FT-3500 Electromagnetic Flow Meters are designed to detect microvolt signal levels at the electrodes located on the sensor head. These signals are generated as conductive fluids flow through the magnetic field generated by the meter. If enough random electrical noise is present at the electrodes, it can interfere with the flow measurement. Care must be taken during installation to minimize the effects of electrical noise on the flow meter.

The most effective way to minimize the effects of electrical noise is to make sure that the pipe, the fluid and the flow meter body are all connected to earth ground. This accomplishes two important goals. First, it ensures that the pipe, fluid and flow meter are all at the same electrical potential, and second, it ensures that this electrical potential is the same as earth ground.

In order to be certain that the meter is properly connected to earth, the flow meter earth cable should be run directly to a known earth connection. The length of this earth cable should be as short as practically possible, preferably ≤ 25 feet in length. The table below lists earth connections from best to worst. If necessary, a separate earth cable should be connected to the metal pipe near the meter.

Earth Connections (stranded wire 14 – 18 AWG)	
Best	Earth grounding rod driven into the ground
	Earth wire connected directly to the building electrical service panel.
Worst	Earth wire connection inside an electrical outlet near the meter.

IMPORTANT NOTE

Under certain circumstances, connecting the meter to earth through the green/yellow earth wire may increase the amount of electrical noise present at the meter. Contact ONICON for technical assistance if you experience increased noise levels with the earth wire connected to earth.

4.0 PROGRAMMING MENU

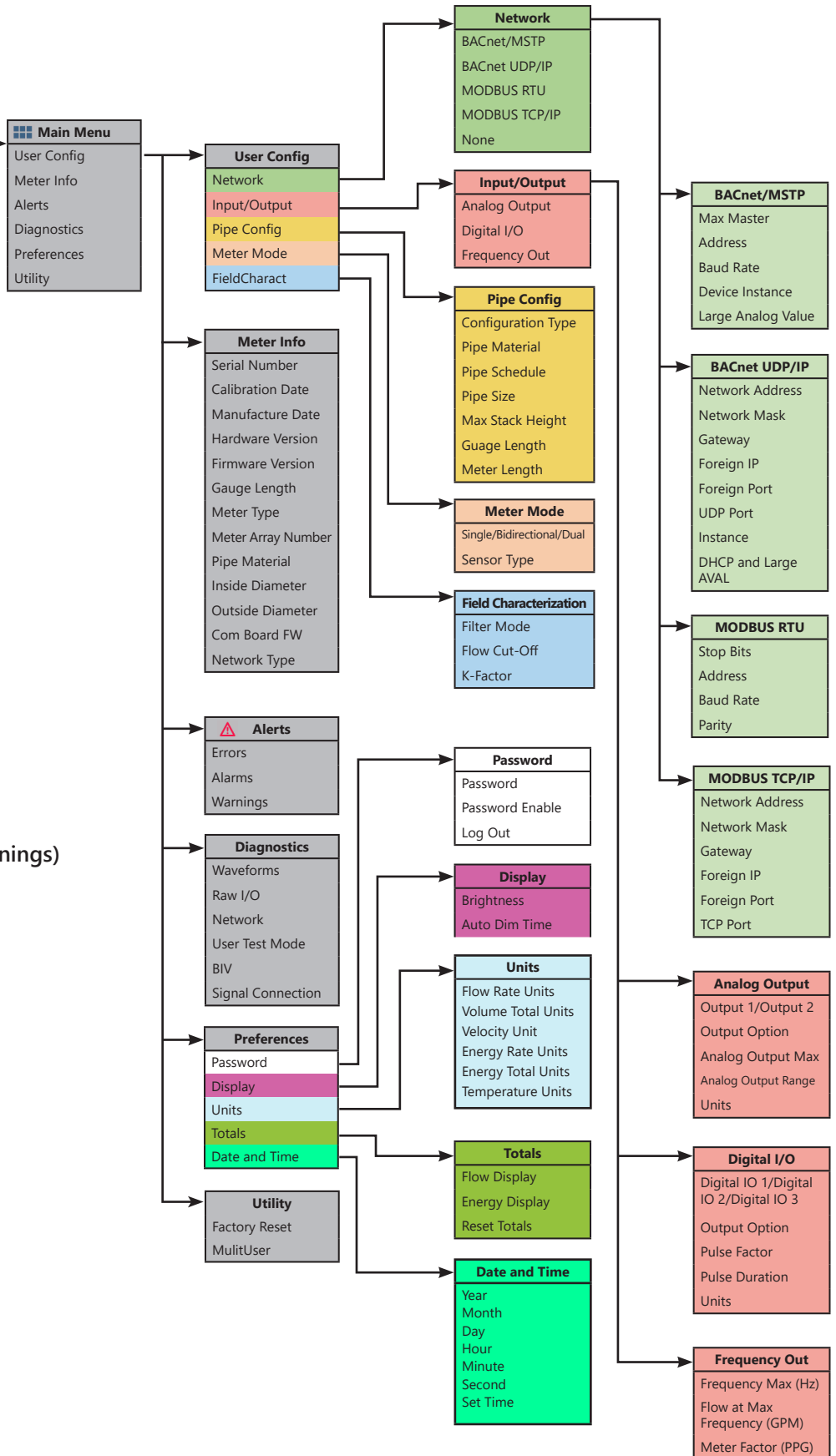
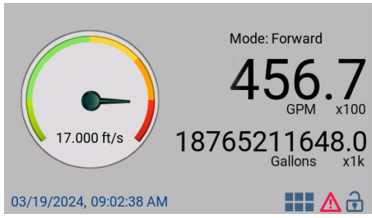

RUN MODE ICONS

- Flow Simulation
- Home Main Display
- Alert (Errors, Alarms, Warnings)
- Lock Mode
- UnLock Mode
- User Mode
- Main Menu
- Back to Main Menu
- Back

Main Screen Page

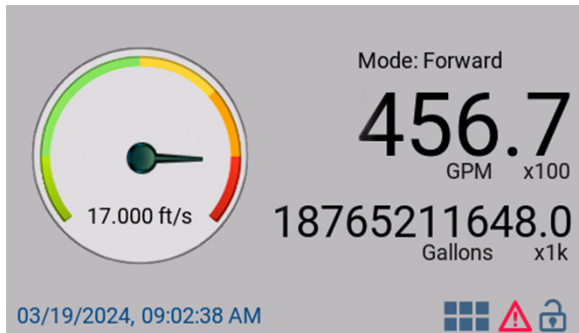

Access this screen by selecting  the home button in the lower-right corner of the screen.

The Main display shows:

Flow rate: Calculated volumetric flow rate based on the pipe size selected and velocity measured.

Volume total: Calculated volumetric total based on the pipe configuration selection and meter mode. If the mode is bidirectional, the meter will display forward volume or reverse volume depending on the flow direction.

Units: The Main Screen will display the units selected under Main Menu->Preference->Units.

Multiplier: The FT-3500 will auto-select the multiplier based on the full scale of the meter.

Velocity Gage: The Main Screen will display the measured velocity in the selected units. The green section is up to 10ft/s. The yellow section is 10-17ft/s. The red section is 17-20ft/s.

Mode Indication: The FT-3500 will indicate the flow mode status based on the selection under Main Menu->Meter Mode->Mode. If bidirectional is selected, the main screen will show Forward vs Reverse flow depending on the direction of the measured flow. If the mode is selected as single, the meter will show forward mode in normal condition and will go to an alarm if it is on reversed flow.

Date and Time: The Main Screen will display the saved date and time.

From the main display page, the user can access the main menu and alerts, and displays the locked or unlocked status. The meter will be unlocked by default, go to Main Menu->Preference->Password to activate and set a password. Refer to page 30 for the Main Screen icons.

Main Menu Page

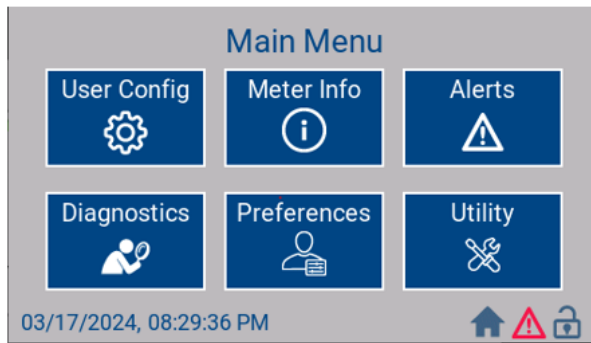

Access this screen by selecting the  "Main Menu" icon in the lower right corner of the screen.

From the main menu, the user can select the following:

User Configuration: The "User Config" section enables the review and customization of the meter network, inputs/ outputs, pipe configurations, operational modes, and field parameters.

Meter Information: The "Meter Info" tab offers quick access to details about the meter, including calibration and production dates, hardware, firmware/GUI versions, pipe specifications, gauge length, and network types.

Alerts: The "Alerts" function provides insights into current errors, alarms, and warnings of the meter. Any detected error or alarm prompts the meter to reset to zero to ensure the user's attention is captured.

Diagnostics: The diagnostics menu, used alongside the alerts function, assists in troubleshooting meter issues. Within this menu, users can view current waveforms, raw and processed input and output data, assess network status and activity, examine signal connections, and simulate flow through the meter to ensure it connects properly to the BMS or PLC.

Preferences: This menu allows users to set a password, adjust display settings, change measurement units, and reset displays of flow totals, date, and time.

Utility: The utility menu allows users to revert to factory settings and to register multiple users for meters utilized across several pipes.

User Configuration

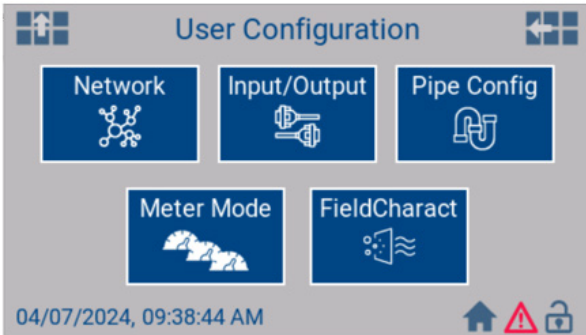

Access this screen through Main Menu --> User Config

User Config: This function enables users to examine and configure the meter’s network, inputs and outputs, pipe setup, operating mode, and field characterization.

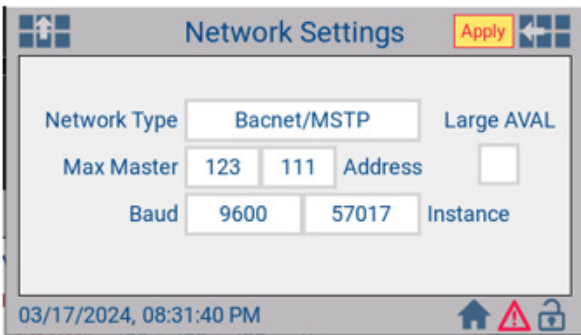

Access this screen through Main Menu --> User Config --> Network

Network Type Settings

The communications menu offers options to choose the meter’s network output. To confirm selections, use the “Apply” button. Available settings include None, BACnet/MSTP, BACnet IP, MODBUS RTU, and MODBUS TCP/IP.

For BACnet/MSTP and MODBUS RTU:

Max Master (BACnet Only): Max number of devices in the trunk range 0-127. A repeater is needed if the trunk has more than 32 devices.

Address: This is the Device ID which must be unique for the device across the whole BACnet network. Range: 0-127

Baud: Baud Rate, or Bits Per Second. Defines the speed of communication on the BUS. Must be the same for all devices on the BUS. Options: 9600, 19200, 38400, 57600, 76800.

Instances (BACnet Only): Provide a unique number for the meter in the trunk.

Stop Bit (MODBUS Only): default to 1

Parity (MODBUS Only): Selectable as None, Even or Odd.

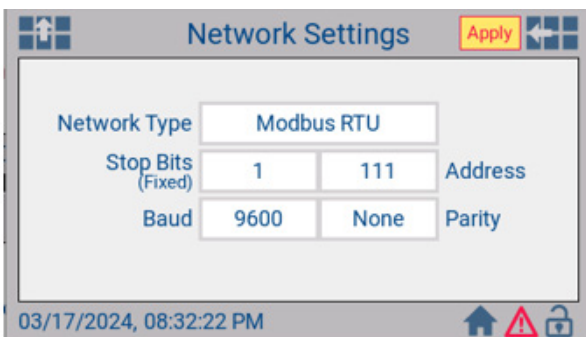

Access this screen through Main Menu --> User Config --> Network

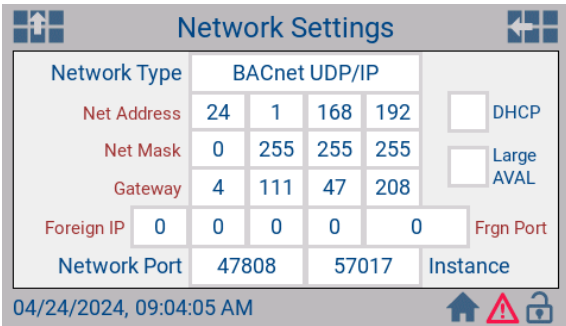

Access this screen through *Main Menu --> User Config --> Network*

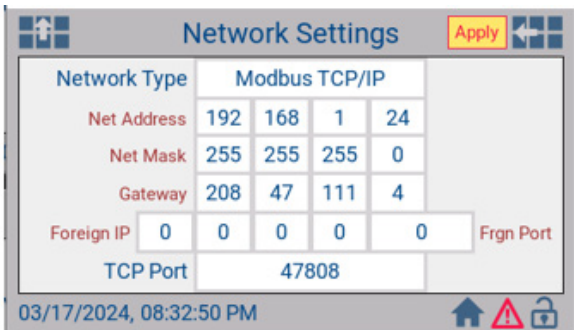

Access this screen through *Main Menu --> User Config --> Network*

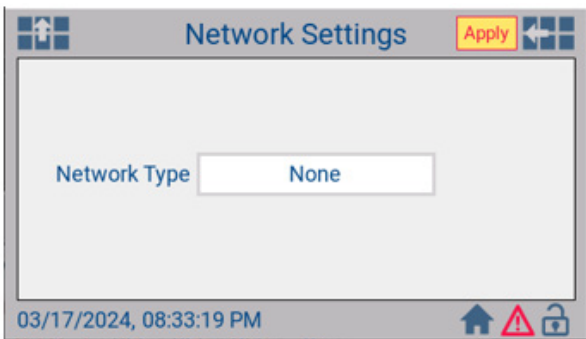

Access this screen through *Main Menu --> User Config --> Network*

For BACnet IP and MODBUS TCP/IP:

Network Address: numerical label assigned to the FT-3500.

Network Mask: Divide the Network address into the subnet and specify the network available.

Gateway: Access point numerical configuration for data to travel between different networks

Foreign IP: If there is a BACnet controller on a different network (via a router) that should be used with the meter, its address is specified in this field.

Foreign Port: If there is a BACnet controller on a different network (via a router) that should be used with the meter, its network port is specified in this field.

TCP Port (MODBUS Only): Specific port assigned to MODBUS TCP/IP network.

UDP Port (BACnet Only): Specific port assigned to BACnet UDP/IP network.

DHCP: Check to activate Dynamic IP Address. Uncheck box means the meter can be configured for Static IP Address.

Inputs & Outputs

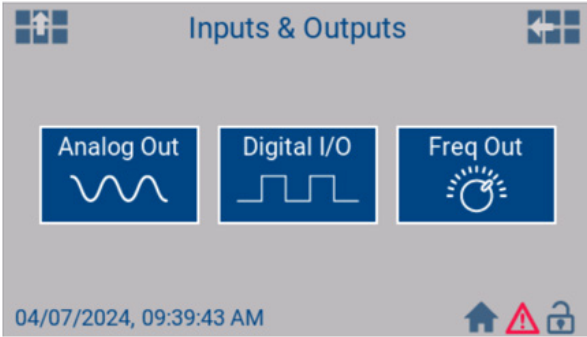

Access this screen through *Main Menu --> User Config --> Input/Output*

Through the Inputs & Outputs screen the user can make changes to analog output, digital input/output, or frequency output.

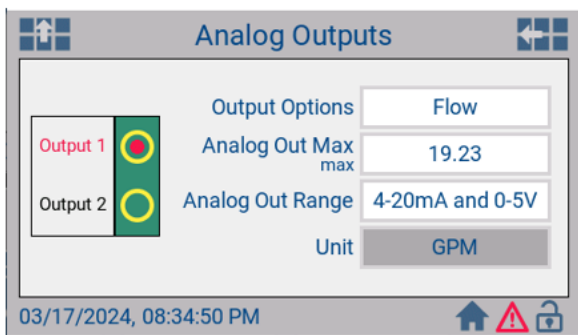

Access this screen through *Main Menu --> User Config --> Input/Output --> Analog Output*

Analog Outputs: FT-3500 has two analog outputs (Terminal TB3-1 and TB3-2). Terminal TB3-1 is Output 1 and terminal TB3-2 is Output 2.

Output Options: Energy, Energy Heating, Energy Cooling, Supply Temp, Return Temp, Delta Temp.

Analog Out Max: Numeric value set via the keypad. If changing this setting, ensure that the new analog out max is greater than the max flow your system can do.

Analog Out Range: Options include 4-20mA and 2-10V, 4-20mA and 1-5V, 4-20mA and 0-10V, 4-20mA and 0-5V. If 4-20mA and 2-10V is selected, the meter will report 2mA or 1V when it is in alarm. If 1-5V is selected, the meter will report 0.5V when it is in alarm. If 0-10V is selected the meter will show 0V when the meter is in an alarm or zero flow.

Units: This option will display the units selected under Main Menu->Preference->Units.

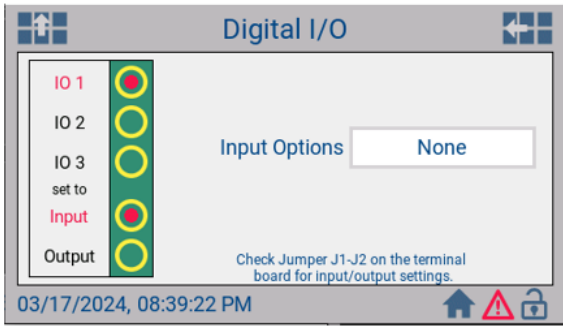

Access this screen through *Main Menu --> User Config --> Input/Output --> Digital I/O*

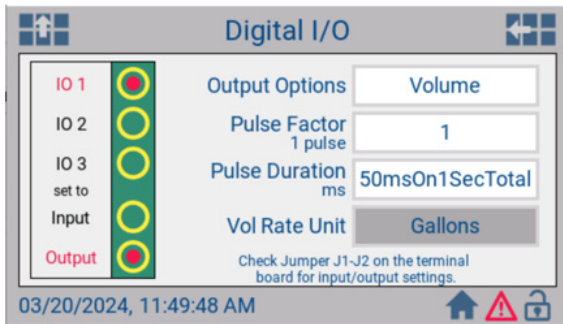

Access this screen through *Main Menu --> User Config --> Input/Output --> Digital I/O*

Digital I/O: Start by selecting which output the user intends to edit: IO 1, IO 2, or IO 3, Set to Input or Output.

IO 1, IO2 or IO3 / Input: configurable as None or Contact Count. This can be used for any close contact totalization meter to be brought to the network.

Note: Set the Jumper J1-J2, J3-J4, J5-J6 on Input position if this feature is needed

IO 1, IO2 or IO3 / Output: Close contact output for the FT-3500. Output Options can be configured to None, Volume, Volume Forward, Volume Reverse, BTU Total Pulse Outputs, Alarm, Mode Status, or Warning

For Volume, Volume Forward, Volume Reverser:

Pulse Factor: 1, 10, 100, 1K, 10K, 100K, or 1M is the quantity of the selected units at which the meter will close the output.

Pulse Duration: Duration of the close contact and the total cycle. Configurable as 50msOn1SecTotal, 100msOn1SecTotal, 500msOn2SecTotal, 1000msOn3SecTotal.

Note: Improper configuration on the unit might result in a pulse over-run alarm.

Units: This option will display the units selected under Main Menu->Preference->Units.

For Alarm:

If this option is selected, the meter will close the contact if it is ever in an alarm state.

For Warning:

If this option is selected, the meter will close the contact if it is ever in warning state.

Note: Warning does not affect the operation of the meter

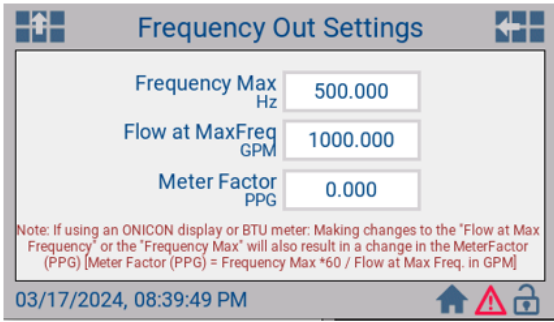

Access this screen through *Main Menu --> User Config --> Input/Output --> Freq. Out*

Frequency Out Settings:

This feature is typically used if the FT-3500 is connecting to an ONICON peripheral such as SYS-10, SYS-20, SYS-1000 or D-100 via Meter Factor. The user can set the Frequency Max (Hz) and the Flow at MaxFreq (GPM) via the keypad.

Note: Making changes to the “Flow at Max Frequency” or the “frequency Max” will also result in a change in the Meter Factor.

$$\text{Meter Factor} = \text{Frequency Max (Hz)} \times 60 / \text{Flow at Max Freq (GPM)}$$

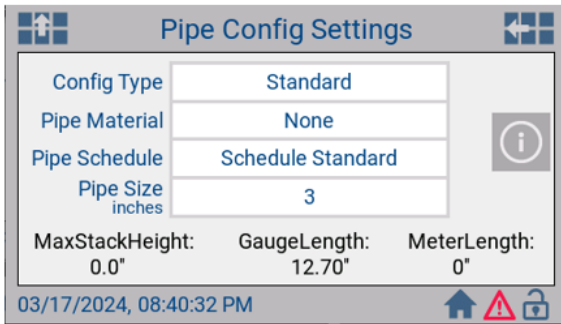

Access this screen through *Main Menu --> User Config --> Pipe Config*

Pipe Config Settings:

The user can set their pipe configuration to either be Standard or Custom.

The pipe size is set per the customer order form but can be manually changed on this screen. Please note that if the meter was originally ordered for a 2 1/2" pipe size or smaller, it must stay in the range of 1 1/4" to 2 1/2". If the meter was originally ordered for a 3" pipe or larger, it must be used in that range. If the user is unsure of the original order size, the sensor type can be found on the Meter Settings menu.

For Standard Configuration

The user can use the next three drop-down boxes to select the common pipe material, pipe schedule, and pipe size. Once saved, the meter MaxStackHeight and GaugeLength will update.

For Custom Pipe Configuration

The user will need to use the drop-down boxes to set the pipe material, inside diameter, and outside diameter (inches). Once saved, the meter MaxStackHeight and GaugeLength will update.

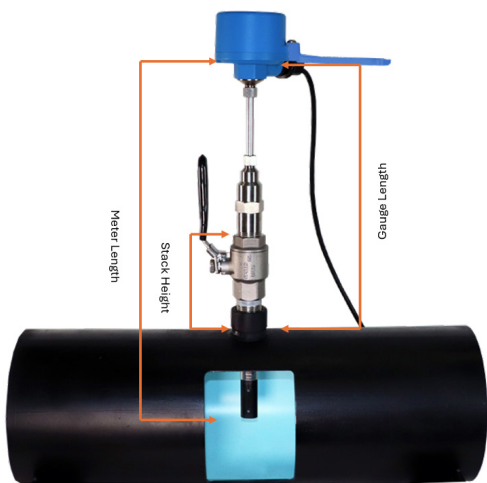

Conductive Magnetic Semi Rough Walled Pipe: refers to any metallic pipe with an inner material texture that is not smooth providing roughness and more friction for the fluid. For example, pipes with similar properties like carbon steel pipes.

Conductive Non-Magnetic Smooth Walled Pipe: refers to any metallic pipe with an inner material texture that is not completely smooth providing some degree of roughness for the fluid. For example, pipes with similar properties like copper pipes.

Nonconductive Nonmagnetic Rough Walled Pipe: has a surface texture that is not smooth, and they are made from materials that do not conduct electricity or exhibit magnetic properties. For example, pipes with similar properties like concrete or concrete-lined pipes.

Nonconductive Nonmagnetic Smooth Walled Pipe: has a smooth surface texture, and they are made from materials that do not conduct electricity or exhibit magnetic properties. For example, pipes with similar properties like PVC, PPR, or other plastic pipes.

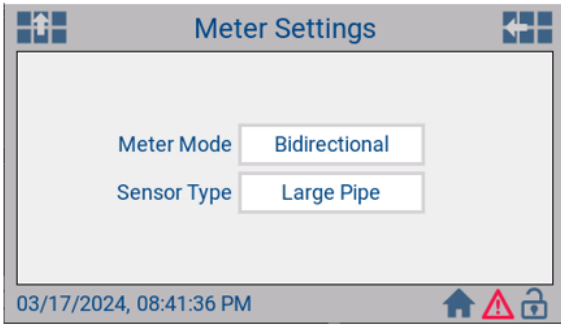

Access this screen through *Main Menu* --> *User Config* --> *Meter Mode*

Meter Settings:

The user can set Meter Mode to be Unidirectional (for a pipe with flow in one direction) or Bidirectional (for a pipe with flow in two directions). Sensor Type is set by ONICON and cannot be updated in the field.

Note: Mode Indication on the main screen will indicate the flow mode status based on the Meter Mode selection. If bidirectional is selected, the main screen will show Forward vs Reverse flow depending on the direction of the measured flow. If the mode is selected as single, the meter will show forward mode in normal condition and will go to an alarm if it is on reversed flow.

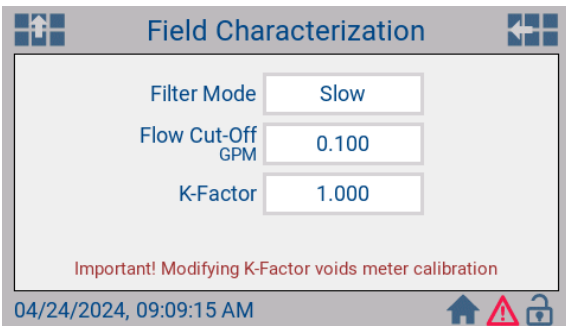

Access this screen through *Main Menu* --> *User Config* --> *Meter Mode*

Field Characterization:

Flow Characterization allows the user to configure the flow reading based on field data and conditions.

Filter Mode: Selection between Slow, Medium, Fast

Advanced / Slow: This filter allows the user to read flow without much reading fluctuation due to environmental noise or flow disturbance on challenging installations like an elbow or tee.

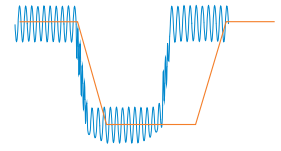

Advanced / Medium: ONICON Default filter

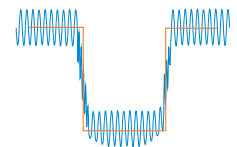

Advanced / Fast: This filter setting can be used if the meter needs to react faster to flow changes.

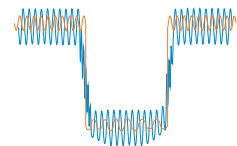

Flow Cut-off: This is the minimum value the meter will read before reporting 0.

K-Factor: Multiplier of the main flow rate measurement. Changing this value will void the calibration of the meter. A proper balance method should be followed before changing this number.

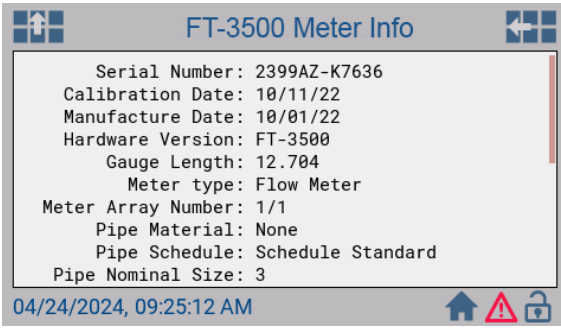

Access this screen through *Main Menu* --> *Meter Mode*

Meter Info

Through the Meter Info screen, the user can access information about their meter including calibration/ manufacturing dates, hardware/ firmware/ GUI versions, pipe information, gauge length, and network types.

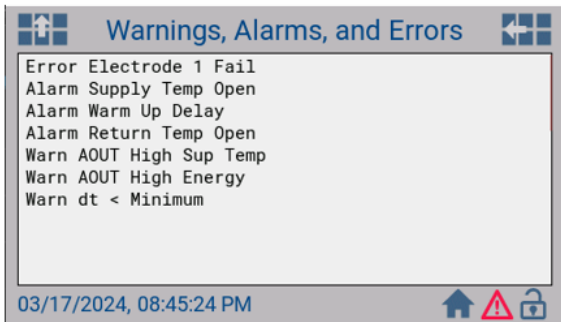

Alerts

Through the Alerts screen, the user can access information regarding active errors, alarms, and warnings. Please refer to Section 6.0 on pages 59-64 of this manual for the full list of warnings, alarms, and errors and their meanings.

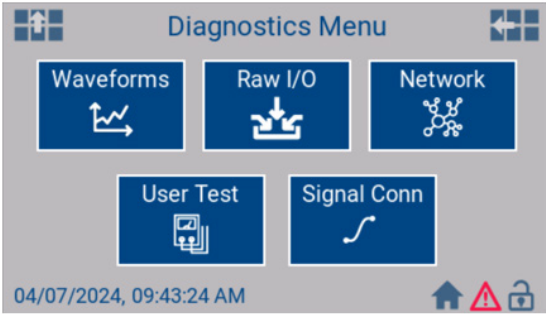

Access this screen through *Main Menu* --> *Diagnostics*

Diagnostics:

The user can use the diagnostics menu, coupled with the alerts menu to help troubleshoot any meter problem. In the diagnostics screen, a user can access the current waveform, raw input and output information, network status/ activity, and signal connections.

Waveforms:

The Waveform screen can help the user identify disturbances to the flow or if there are any problems in the signal between the meters electrodes.

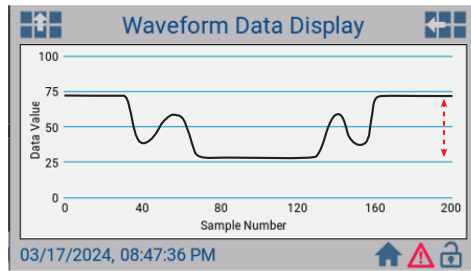

Flow without noise (IDEAL)

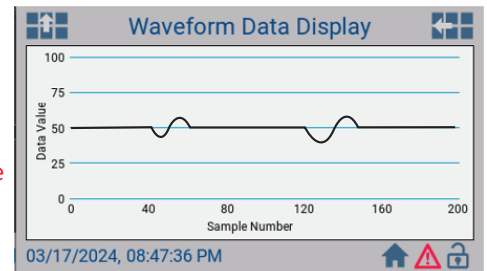

No flow without noise

Amplitude of the signal depends on the flow rate

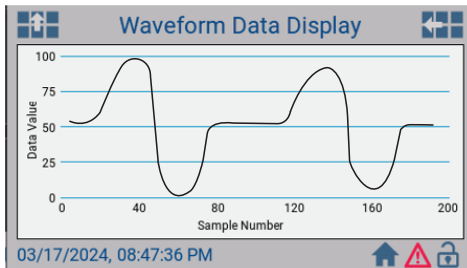

Empty pipe (Check installation)

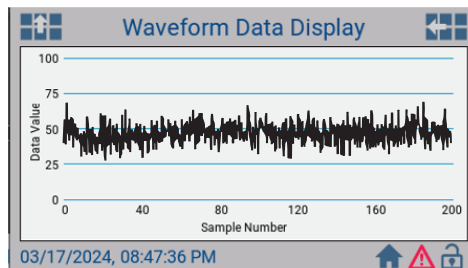

Low flow with noise (Check grounding)

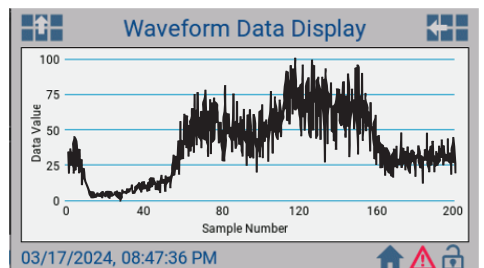

High flow with noise (Check grounding)

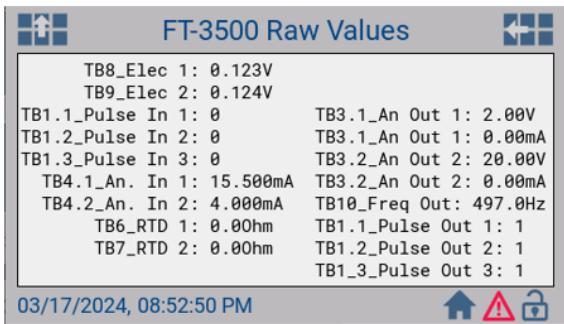

Raw I/O:

The FT-3500 Raw Values screen will show the user the voltage of electrodes 1 and 2, the raw values for pulse and analog inputs/ outputs, and the current or resistance from the temperature sensors (if using the FT-3500 as an energy meter).

NOTE: TB9_Elec 2 will be zero for small pipe configurations, pipe sizes ranging from 1 1/4" to 2 1/2". If the user is unsure of the meter configuration, the sensor type can be found on the Meter Settings menu.

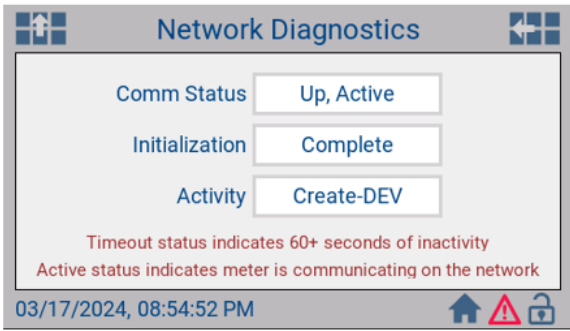

Network Diagnostics:

The user can verify their communication status via the Network Diagnostics screen.

Comm Status:

Down: No traffic has been seen in 60 seconds

Up, Active: Traffic has been seen in the last 60 seconds, and the meter is talking to the network.

Up, Inactive: Traffic has been seen in the last 60 seconds, and the meter is not talking to the network.

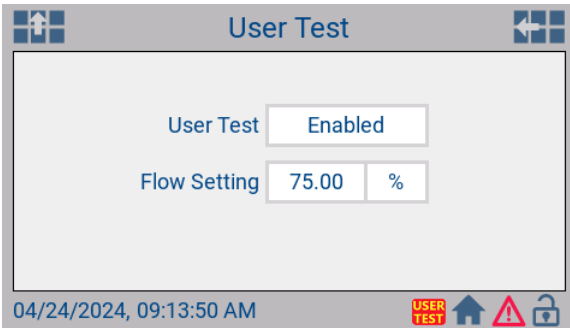

User Test:

The user test mode can be enabled to allow the user to simulate flow. When User Test is enabled, the user will see a red user test symbol located in the bottom right corner next to the home icon.

While in User Test mode, the user can simulate flow by:

- Percentage of full scale.
- Feet per minute.
- Gallon per minute.

To exit out of the User Test mode, set the first drop-down box to "Disabled".

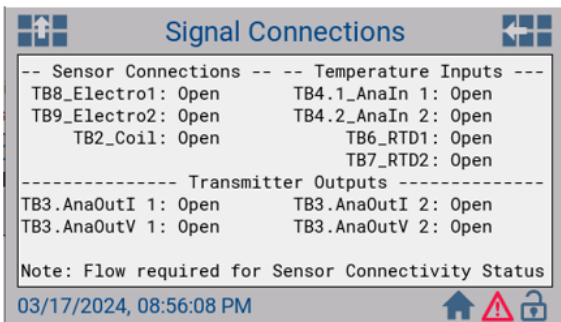

Signal Connections:

The signal connections screen will give the user the connection status of the meter’s electromagnetic sensors/coil, temperature sensors/ RTDs (if using as an energy meter), and transmitter output status.

Note that flow is required for an accurate sensor connectivity status.

Note that TB9_Electro2 will not show for small pipe sensors, 1 1/4" to 2 1/2".

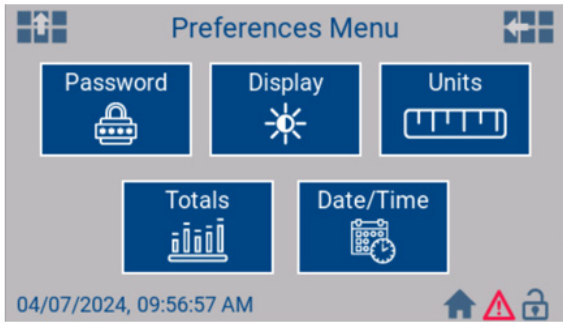

Preferences:

The user can use the preferences menu to enable a password, change display settings, change units, and edit flow/ totals display, date and time.

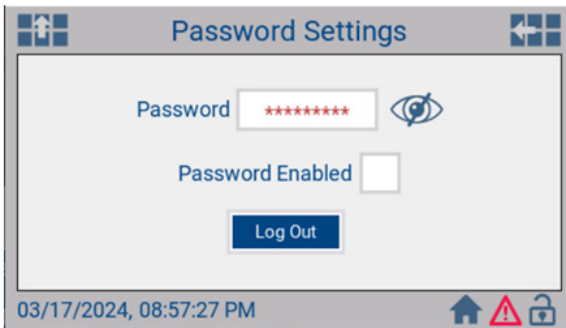

Password Settings:

In the Password Settings screen, the user can enable a password of their choosing that can be used to control access to flow meter settings. If password is enabled, the end-user still has access to the main screen, diagnostics, meter info, and alerts.

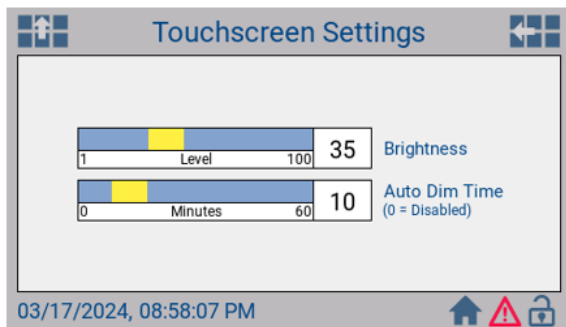

Display / Touchscreen Settings:

The user can adjust the brightness from this screen. The user can also use this screen to set the amount of time before the screen dims after being touched. If the user wants the screen to always be illuminated, set the auto dim time to 0.

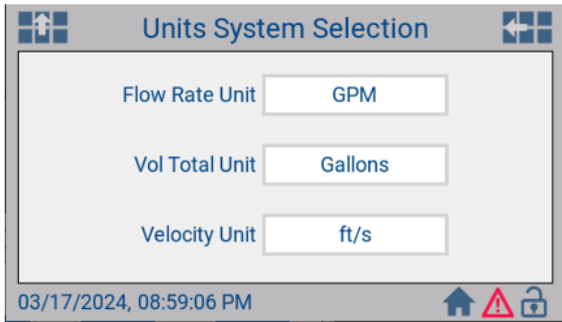

Units System Selection:

In this screen, the user can set Flow Rate Units, Vol Total Units, and Velocity Units.

Flow Rate Units: GPM, L/S, L/M, CM/H, CFT/S, CM/S

Vol Total Units: Gallons, Liters, CM

Velocity Units: ft/s, m/s

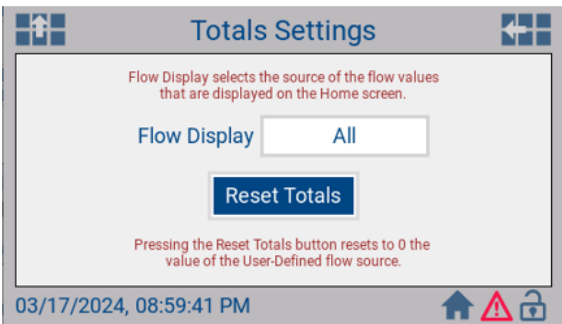
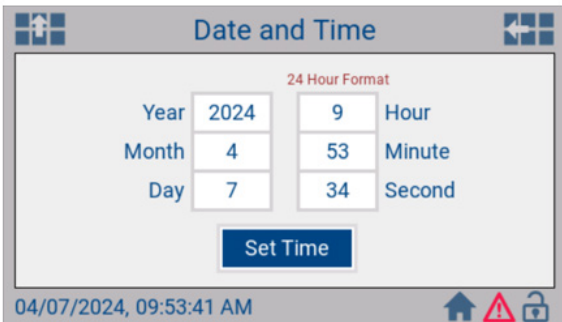

Table Settings:

The user can utilize this screen to set their flow totals display settings, specifically how the flow totals will display on the Home Screen. Pressing "Reset Totals" will only reset the user define totals.



Date and Time:

User can set the date and time of their ideal time zone and location. Set the time in a 24-hour format. The main display will be in a 12-hour format.

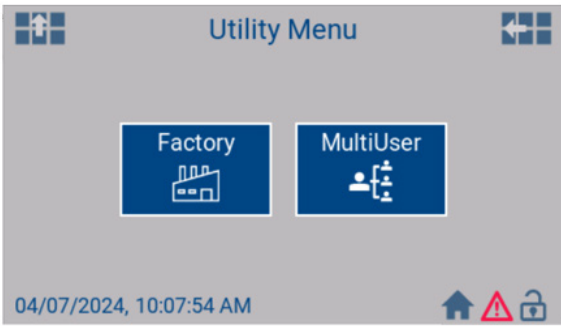

Utility Menu:

The user can utilize the Utility Menu to restore factory settings or MultiUser Configuration

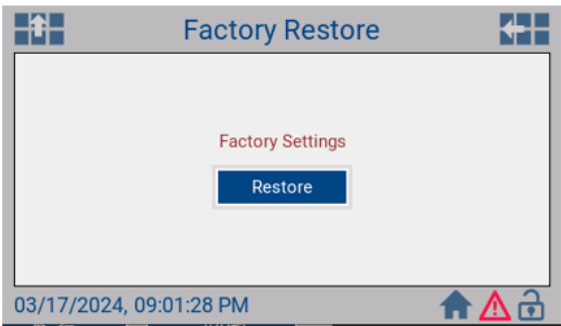

Factory Restore:

The "Restore" button will recover all preferences set from the factory.

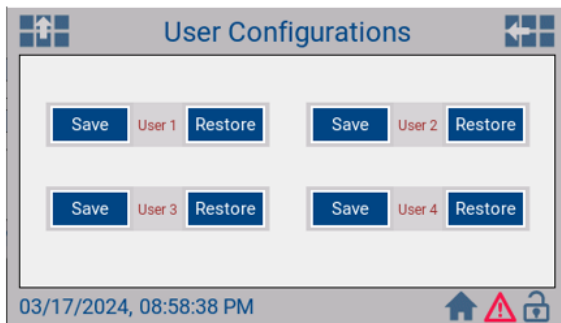

Multuser / User Configurations:

The FT-3500 allows the user to save up to 4 separate meter preferences. This feature can be utilized when a meter is used in multiple pipes. Once pipe configurations, I/O, and network configurations are set, the user can save the preferences via this screen. To restore the settings after a change, the user will need to select restore.

SECTION 5.0: START-UP & COMMISSIONING FOR ONICON INSERTION ELECTROMAGNETIC FLOW METERS



5.1 HELPFUL HINTS FOR START-UP AND COMMISSIONING

A step-by-step procedure and companion worksheet are located on the next two pages. Please read all installation instructions carefully before proceeding with installation, start-up and commissioning.

Please read these helpful hints before proceeding with the start-up and commissioning procedure on the next page.

1. ONICON flow meters are individually calibrated for a particular application. Be sure to verify the pipe size and location.
2. The electronic flow sensing systems will not work in air.
3. When measuring analog output signals, remember that current (mA) must be measured in series, while voltage is measured in parallel. If the 4-20 mA signal is already connected to a control system, you must break the connection and measure the signal in series.
4. When measuring frequency outputs in Hz, take your multimeter out of "auto-range mode" and manually set the range for a voltage level above 15 VDC. This will prevent false readings when signal is not present.
5. All wiring connections should be made at the end of the factory cable. Do not attempt to remove the factory installed cable or change the orientation of the electronics enclosure.
6. Never connect power to analog or frequency output signal wires. ONICON FT-3500 Flow meters are not "loop powered" devices.

5.2 START-UP AND COMMISSIONING

Please read the entire procedure before proceeding. A worksheet for checking off the following steps and recording measured values is located on the next page.



1.	Confirm flow meter location. Confirm adequate straight pipe run to achieve desired results.	Is the meter located in the correct location as required by the plans? Compare actual straight pipe upstream and downstream of the meter location to recommended distances identified in this manual. Contact ONICON's technical support department to discuss specifics of your application. If straight pipe run is very short, consult factory PRIOR to installing the meter to discuss possibility of upgrade to an FT-3000 series inline meter.
2.	Confirm pipe size.	Confirm that the meter is tagged for the pipe size in which it is installed. When in doubt, measure the circumference of the pipe. Pipe O.D. = (circumference / 3.14) – (insulation thickness x 2).
3.	Confirm insertion depth and orientation.	Standard configuration meters come with an insertion depth gauge and instruction tag. Small pipe configuration meters come with an insertion depth tool. Ensure that the meter is inserted to the correct depth and that the electronics enclosure is parallel with the pipe with the arrow in the direction of flow.
4.	Confirm control system programming.	Confirm that the control system input point is properly configured for the analog range (or scale factor) identified on the calibration tag & certificate.
5.	Confirm connection to correct ONICON display or BTU meter (if ordered).	Confirm that the flow meter serial number matches the ONICON display or BTU meter serial number (when ordered together).
6.	Verify wiring before connecting power.	Prior to connecting the power, verify that the wiring is correct as shown in this manual and/or the additional wiring diagram provided with ONICON display or BTU meter. If in doubt, contact ONICON for assistance before proceeding further.
7.	Confirm correct supply voltage.	Verify that 24 (+/-2) DCV or 24 (+/-4) ACV is available.
8.	Connect power.	Wait approximately 45 seconds after power-on before proceeding further.
The following steps require flow in the pipe. Flow signal readings should be taken while holding the flow rate constant, if possible. Otherwise, take the various output readings as quickly as possible.		
9.	Measure and record frequency output.	The frequency output signal is a 15 VDC pulsed output ranging up to 200 Hz and must be measured with a multimeter. Measure DC frequency (Hz) from GREEN(+) to YELLOW(-). Also measure DC volts on same wires. Five to 7 VDC is normal for a pulsating output. Zero VDC indicates no output. $\text{GPM} = \frac{\text{frequency in Hz} \times 60}{\text{meter factor in ppg}}$ (Refer to calibration tag for meter factor.)
10.	Measure and record analog or pulse outputs. Current Output: Voltage Output (if configured to 0-10VDC): Voltage Output (if configured to 2-10VDC): Scaled Output:	Refer to flow meter wiring diagram for wire colors for the various outputs available, based on your particular flow meter model. Use the following formulas to calculate flow rate from measured analog signals: $\text{GPM} = \frac{(\text{measured current in mA} - 4) \times \text{Full Scale Analog Flow Rate}}{16}$ $\text{GPM} = \frac{\text{measured VDC} \times \text{Full Scale Analog Flow Rate}}{10}$ $\text{GPM} = \frac{(\text{measured VDC} - 2) \times \text{Full Scale Analog Flow Rate}}{8}$ Each contact closure = unit volume identified as "Scale Factor" (measure and record time interval between contact closures)
11.	Compare various output signals to each other and to the flow rate displayed by the control system.	Compare the flow rates calculated in steps 9 and 10 to each other and to the flow rate indicated by the control system. Refer to troubleshooting guide when readings are inconsistent.
End of standard start-up and commissioning. Please contact ONICON at +1 (727) 447-6140 with any questions.		

5.3 START-UP AND COMMISSIONING WORKSHEET

Please read all installation (Sec 3) and commissioning (Sec 4) instructions carefully prior to proceeding with these steps. Use the following worksheet for checking off the commissioning steps and recording measured values. The following steps require flow in the pipe. Flow signal readings should be taken while holding the flow rate constant, if possible. Otherwise, take the various output readings as quickly as possible.

STEP	TEST/MEASUREMENT	S/N: _____	S/N: _____	S/N: _____	S/N: _____
1.	Meter location:				
2.	Confirm pipe size:	_____	_____	_____	_____
3.	Insertion depth and orientation:				
4.	Control system programming:				
5.	Match display or BTU meter serial number (S/N):	_____	_____	_____	_____
6.	Signal connections verified:				
7.	Supply voltage verified:	_____	_____	_____	_____
8.	Connect power:				
The following steps require flow in the pipe. Flow signal readings should be taken while holding the flow rate constant if possible, otherwise, take the various output readings as quickly as possible.					
9.	Frequency output(s): Avg = green Average frequency (Hz): Average frequency (VDC): Calculated flow rate:	_____ Hz _____ VDC _____ GPM	_____ Hz _____ VDC _____ GPM	_____ Hz _____ VDC _____ GPM	_____ Hz _____ VDC _____ GPM
10.	Analog or pulse output(s) 4-20 mA signal: 2-10, 1-5, 0-10 or 0-5VDC Signal (select one): Scaled output interval: Calculated flow rate:	_____ mA _____ VDC _____ GPM	_____ mA _____ VDC _____ GPM	_____ mA _____ VDC _____ GPM	_____ mA _____ VDC _____ GPM
11.	Flow rate displayed by control system:	_____ GPM	_____ GPM	_____ GPM	_____ GPM

5.4 NETWORK CONFIGURATION

Connecting via RS-485	Connecting via IP																				
<p>1. Power on unit to verify is it functioning properly. Once verified, power unit down.</p>	<p>1. Power on unit to verify is it functioning properly. Once verified, power unit down.</p>																				
<p>2. Wire MS/TP cables to unit.</p> <ul style="list-style-type: none"> • The RS485 network cable connections are polarity sensitive and must be connected the same way on every device (i.e. + to + and - to -). • Shield drain connections should be daisy chained in the same manner as the signal cables for RS485. The shield drain wire should be left unterminated at the end of the cable and connected to shield only at the network master controller. Shield wires must not be connected to the RS485 connector on the FT-3500. • The maximum number of devices allowed on an RS485 network segment without a repeater is 32. Adding more than 32 devices to a single segment may reduce the transceiver output voltage to a level that is too low to be distinguished from background noise on the cable. 	<p>2. Connect ethernet cable to unit.</p>																				
<p>3. Connect power to unit.</p>	<p>3. Connect power to unit.</p>																				
<p>4. Navigate to the systems network configuration. From the main menu select:</p>  → User Configurations → Network → BACnet MS/TP or MODBUS RTU	<p>4. Navigate to the systems network configuration. From the main menu select:</p>  → User Configurations → Network → BACnet UDP/IP or MODBUS TCP/IP																				
<p>5. Configure device as needed. Default values are listed below.</p> <table border="1" data-bbox="154 1249 803 1444"> <tr> <td>Baud Rates</td> <td>38400</td> </tr> <tr> <td>Device Address</td> <td>17 (Default)</td> </tr> <tr> <td>Device Instance</td> <td>57017</td> </tr> <tr> <td>Max Master</td> <td>127</td> </tr> </table>	Baud Rates	38400	Device Address	17 (Default)	Device Instance	57017	Max Master	127	<p>5. Configure device as needed. Default values are listed below.</p> <table border="1" data-bbox="868 1234 1518 1480"> <tr> <td>Default Address</td> <td>192.168.1.24</td> </tr> <tr> <td>Instance Number</td> <td>57017</td> </tr> <tr> <td>Subnet Mask</td> <td>255.255.255.0</td> </tr> <tr> <td>Gateway Address</td> <td>Programmable</td> </tr> <tr> <td>UDP port (BACnet)</td> <td>47808</td> </tr> <tr> <td>TCP port (MODBUS only)</td> <td>502</td> </tr> </table>	Default Address	192.168.1.24	Instance Number	57017	Subnet Mask	255.255.255.0	Gateway Address	Programmable	UDP port (BACnet)	47808	TCP port (MODBUS only)	502
Baud Rates	38400																				
Device Address	17 (Default)																				
Device Instance	57017																				
Max Master	127																				
Default Address	192.168.1.24																				
Instance Number	57017																				
Subnet Mask	255.255.255.0																				
Gateway Address	Programmable																				
UDP port (BACnet)	47808																				
TCP port (MODBUS only)	502																				

Checking Network Status

Check section 4.2.5.3 in this manual for Network Connection Status.

**IMPORTANT NOTE FOR BACnet MS/TP CONNECTIONS**

If the meter is not connected to an active network the following electrical testing can be performed with a multimeter. If the readings are outside for the normal ranges listed below, please refer to manual for common issues.

- I. Check Resistance (set multimeter to Ohms)
 - Shield
 - Earth GroundNormal reading: 0 Ohms

- II. Check DC Voltage (set multimeter to DC)
 - A-
 - B+Normal reading: 0.2 VDC

- III. Check DC Voltage (set multimeter to DC)
 - Earth Ground
 - B+Normal reading: 2.0 - 2.5 VDC

- IV. Check DC Voltage (set multimeter to DC)
 - Earth Ground
 - A-Normal reading: 2.0 - 2.5 VDC

- V. Check DC Voltage (set multimeter to DC)
 - B+
 - Earth GroundNormal reading: Less than 2.0 VDC

- VI. Check DC Voltage (set multimeter to DC)
 - A-
 - Earth GroundNormal reading: Less than 2.0 VDC

BACnet Protocol Implementation Conformance Statement

Date: 01/03/2023

Vendor Name: ONICON Inc.

Product Name: FT-3500

Product Model Number: FT-3500-1 and FT-3500-2

Application Software Version: 2.6.0

Firmware Revision: 1.8.0

BACnet Protocol Revision: 16

BACnet Standardized Device Profiles Supported (Annex L):

- BACnet Application Specific Controller (B-ASC)

BACnet Interoperability Building Blocks Supported (Annex K): DS-RP-B, DS-RPM-B, DS-WP-B, DS-WPM-B, DS-COV-B, AE-N-I-B, AE-ACK-B, AE-INFO-B, AE-CRL-B, DM-DDB-B, DM-DOB-B, DM-DCC-B, DM-TS-B, DM-UTC-B, DM-RD-B

Segmentation Capability:

- Able to transmit segmented messages Window Size _____
- Able to receive segmented messages Window Size _____

Standard Object Types Supported:

The properties below are only those whose presence or writability exceed the minimum requirements of the published ASHRAE BACnet Standard. Properties denoted with (W) are those that are not required to be writable but which have had the ability enabled. All other properties not shown that are required to be present, readable, and/or writable are in accordance with the Standard.

Dynamic object creation and deletion is not supported for any object type.

Analog Input

Required Properties:

- Object Name (W)
- Present Value (commandable when "Out of Service" is True)

Optional Properties Supported:

- Description (W), COV Increment (W), Time Delay (W), Notification Class, High Limit (W), Low Limit (W), Deadband (W), Limit Enable (W), Event Enable (W), Acked Transition Bits, Notify Type, Event Time Stamps, Event Text Messages, Event Algorithm Inhibit Ref, Event Algorithm Inhibit

Analog Value

Required Properties:

- Object Name (W)
- Present Value ("user defined" and "aux" pulse total AV objects are resettable by writing 0)

Optional Properties Supported:

- Description (W), Priority Array, COV Increment (W), Relinquish Default

Binary Input

Required Properties:

- Object Name

Optional Properties Supported:

- Description (W), Inactive Text, Active Text

Binary Value

Required Properties:

- Object Name (W), Present Value (W)

Optional Properties Supported:

- Description (W), Inactive Text, Active Text, Priority Array (W), Relinquish Default (W)

Device

Required Properties:

Object Identifier (W), Object Name (W), APDU Timeout (W), Number of APDU Retries (W)

Optional Properties Supported:

Description C, Local Date (W), Local Time (W), UTC Offset (W), Daylight Savings Status (W), Max Master (W), Max Info Frames (W)

File

Required Properties:

Object Name (W)

Optional Properties Supported:

Description (W)

Multi-state Value

Required Properties:

Object Name (W)

Optional Properties Supported:

Description (W), State Text

Notification Class

Required Properties:

Object Name, (W) Ack Required (W), Recipient List (W)

Optional Properties Supported:

Description (W)

Large Analog Value

Required Properties:

Object Name (W)

Present Value ("user defined" and "aux" pulse total AV objects are resettable by writing 0)

Optional Properties Supported:

Description (W), Priority Array, COV Increment (W), Relinquish Default

BACnet Data Link Layer Options:

- BACnet IP, (Annex J)
- MS/TP master (Clause 9)
- Master Slave
- Non-isolated transceiver Isolated transceiver
- Local 47K ohms bias resistors None Other: _____
- Transceiver unit loading: 1 1/2 1/4 1/8
- Data rates: 9600 19200 38400 57600 76800 115200

Device Address Binding:

Is static device binding supported? (This is currently necessary for two-way communication with MS/TP slaves and certain other devices.) Yes No

Character Sets Supported:

Indicating support for multiple character sets does not imply that they can all be supported simultaneously.

- ISO 10646 (UTF-8) IBM™/Microsoft™ DBCS ISO 8859-1
- ISO 10646 (UCS-2) ISO 10646 (UCS-4) JIS X 0208

Fault = Alarm (Empty pipe, Electrode Disconnect, etc.)
 Offlimit = Warn Low Flow

ANALOG INPUT(S)

Objects List		
Object Identifier	Function	UNITS
Analog Input 1	Energy Rate	BTU/Hr, Kw, or Tons
Analog Input 2	Volume Rate	L/Sec, L/Min, L/Hr, M ³ /Hr, GPM, CFS, or CFM
Analog Input 3	Supply Temperature	°C or °F
Analog Input 4	Return Temperature	°C or °F
Analog Input 5	Delta Temperature	°C or °F

ANALOG VALUE(S)

Objects List		
Object Identifier	Function	UNITS
Analog Value 1	Mode 1 Energy Total	BTU, TonHrs, or kWhrs
Analog Value 2	Mode 1 Volume Total	Liters, M ³ , Gallons, or Ft ³
Analog Value 3	Mode 2 Energy Total	BTU, TonHrs, or kWhrs
Analog Value 4	Mode 2 Volume Total	Liters, M ³ , Gallons, or Ft ³
Analog Value 5	Aux Input 1 Total	Counts
Analog Value 6	Aux Input 2 Total	Counts
Analog Value 7	Aux Input 3 Total	Counts
Analog Value 8	Total Run Hr	Hr
Analog Value 9	Run Hr Mode 1	Hr
Analog Value 10	Run Hr Mode 2	Hr
Analog Value 11	Mode 1 YTD Energy Total	BTU, TonHrs, or kWhrs
Analog Value 12	Mode 1 PrevYr Energy Total	BTU, TonHrs, or kWhrs
Analog Value 13	Mode 1 User Energy Total	BTU, TonHrs, or kWhrs
Analog Value 14	Mode 1 Yesterday Energy Total	BTU, TonHrs, or kWhrs
Analog Value 15	Mode 1 Last 30 Days Energy Total	BTU, TonHrs, or kWhrs
Analog Value 16	Mode 1 YTD Volume Total	Liters, M ³ , Gallons, or Ft ³
Analog Value 17	Mode 1 PrevYr Volume Total	Liters, M ³ , Gallons, or Ft ³
Analog Value 18	Mode 1 User Volume Total	Liters, M ³ , Gallons, or Ft ³
Analog Value 19	Mode 1 Yesterday Volume Total	Liters, M ³ , Gallons, or Ft ³
Analog Value 20	Mode 1 Last 30 Days Volume Total	Liters, M ³ , Gallons, or Ft ³
Analog Value 21	Mode 2 YTD Energy Total	BTU, TonHrs, or kWhrs
Analog Value 22	Mode 2 PrevYr Energy Total	BTU, TonHrs, or kWhrs
Analog Value 23	Mode 2 User Energy Total	BTU, TonHrs, or kWhrs
Analog Value 24	Mode 2 Yesterday Energy Total	BTU, TonHrs, or kWhrs
Analog Value 25	Mode 2 Last 30 Days Energy Total	BTU, TonHrs, or kWhrs
Analog Value 26	Mode 2 YTD Volume Total	Liters, M ³ , Gallons, or Ft ³
Analog Value 27	Mode 2 PrevYr Volume Total	Liters, M ³ , Gallons, or Ft ³
Analog Value 28	Mode 2 User Volume Total	Liters, M ³ , Gallons, or Ft ³
Analog Value 29	Mode 2 Yesterday Volume Total	Liters, M ³ , Gallons, or Ft ³
Analog Value 30	Mode 2 Last 30 Days Volume Total	Liters, M ³ , Gallons, or Ft ³

BINARY INPUT

Objects List		
Object Identifier	Function	UNITS
BI 0	Mode Indication	Indicates current operating mode (Mode 1 or Mode 2) for Channel 1. Mode 1 = Forward Cooling / Mode 2 = Reverse Heating

MULIT-STATE VALUE

Objects List		
Object Identifier	Object Name	Description
MSV 0	Errors	18 states that indicate hardware or functional failures <ol style="list-style-type: none"> 1. Normal 2. EEPROMFail 3. I2CFail 4. VelTblCrrpt 5. PipCfgMssng 6. GrnTtlCrrpt 7. YrTtlCrrpt 8. ElecDiffOOR 9. Elec0 D/C 10. Elec1 D/C 11. ElecBckwrds 12. CoilOpen 13. CoilShort 14. CoilOOR 15. EmptyPipe 16. BrdTempFail 17. 3.3VRailLow 18. RtcFail

5.5 TROUBLESHOOTING GUIDE

NOTE: Also refer to the START-UP AND COMMISSIONING GUIDE located on page 46/47.

REPORTED PROBLEM	POSSIBLE SOLUTIONS
No signal	<ul style="list-style-type: none"> • Verify that the meter is properly inserted into the pipe. • Verify that the remote sensor flow arrow points in the direction of flow in the pipe. • Verify 24 V supply voltage. • Verify correct wiring to control system (see wiring diagram). • Verify that there is flow in the pipe. • Verify that the meter earth cable is connected to earth. • Low conductivity water ($\leq 20 \mu\text{siemens}$) may activate the empty pipe detector and/or increase the potential for electrical noise problems.
Reading is too high or low	<ul style="list-style-type: none"> • Verify pipe size. Contact ONICON if pipe size is different from calibration tag. • Verify that the meter is properly inserted into the pipe. • Verify that the remote sensor flow arrow points in the direction of flow in the pipe. • Verify correct wiring to control system (see wiring diagram). • Confirm that the output signals are consistent with each other (frequency vs. analog, etc). • Confirm that the control system is programmed for correct flow range or scale factor. • Verify that the meter earth cable is connected to earth. A poor earth connection can lead to excessive noise that can affect the flow reading.
Analog signal seems high or low and does not correspond to frequency output	<ul style="list-style-type: none"> • Verify Analog Out Max and Flow at MaxFreq • Check for ground loop or offset voltage: • Disconnect analog signal input from control system and measure analog output directly from the flow meter. Reconnect signal input to control system and measure the analog signals again. Any difference between these readings indicates a potential ground loop or offset voltage. Please contact ONICON for further assistance.
Control system displays flow rate, but no flow rate is indicated on the local display module or BTU meter	<ul style="list-style-type: none"> • Verify that all wires from the flow meter are connected to the display module or BTU meter. • The frequency output wires (green and yellow) must be connected for any ONICON display or BTU meter.
Erroneously high temperature value is present	<ul style="list-style-type: none"> • Check if terminal TB4 or TB6, depending on sensor type, is shorted.

5.4.1 Earth Connections & Electrical Noise Reduction

Introduction

FT-3500 electromagnetic flow meters are designed to detect microvolt signal levels at the electrodes located on the sensor head. These signals are generated as conductive fluids flow through the magnetic field generated by the meter. If enough random electrical noise is present at the electrodes, it can interfere with the flow signal measurement. Care must be taken during installation to minimize the effects of electrical noise on the flow meter.

IMPORTANT NOTE

Non-metallic pipes are more susceptible to electrical noise. Grounding rings installed upstream and downstream of the meter location to reduce the electrical noise present in the pipe may be required for proper operation. Refer to section 1.5.1 and section 3.1 of this manual for additional information on the use of grounding rings.

Minimizing Electrical Noise

The most effective way to minimize the effects of electrical noise is to make sure that the pipe, the fluid and the flow meter body are all connected to earth ground. This accomplishes two important goals. First, it ensures that the pipe, fluid and flow meter are all at the same electrical potential. Second, it ensures that this electrical potential is the same as earth ground.

In order to be certain that the meter is properly connected to earth, the flow meter earth cable should be run directly to a known earth connection. The length of this earth cable should be as short as practically possible, preferably ≤ 25 feet in length. The table below lists earth connections from best to worst. If necessary, a separate earth cable should be connected to the metal pipe near the meter.

Earth Connections (stranded wire 14 - 18 AWG)	
Best	Earth grounding rod driven into the ground to the depth of the water table.
	Earth wire connected directly to the building electrical service panel.
Worst	Earth wire connection inside an electrical outlet near the meter.

Diagnosing Electrical Noise Problems

When diagnosing electrical noise problems, it is important to understand that one of four possible conditions are likely to exist. They are as listed in the table below. In order to minimize the effects of noise, it is helpful to understand which of the following conditions are present.

Earth Connection at Flow Meter	Pipe / Fluid Earth Connection	Expected Noise Level	Possible Remedies
Good earth connection ≤ 25 feet from flow meter	Pipe & fluid are connected to earth	Low	None required
Good earth connection ≤ 25 feet from flow meter	Pipe & fluid are not connected to earth	Moderate	A separate earth connection can be made directly to the metal pipe or to the fluid. Non-metallic pipes may require grounding rings installed upstream and downstream of the meter location.
Poor earth connection	Pipe & fluid are connected to earth	Moderate	Removing the earth connection at the flow meter may reduce the noise level. If this is a long wire run, break the connection where the wire connects to the cable coming out of the flow meter. If noise level is still too high, locate a better earth connection for the flow meter.
Poor earth connection	Pipe & fluid are not connected to earth	High	Locate a better earth connection for the flow meter. If noise level is still too high, locate a better earth connection for the pipe or fluid.

6.0 ERRORS

ALERT	POTENTIAL ISSUE	POSSIBLE SOLUTION
"Error EEPROM fail"	H/W failure of meter non-volatile storage	Contact ONICON. RMA needed
"Error SPI/I2C fail"	Meter internal communication bus failure Loose ribbon cable between the main board and the touch screen.	Check power supply to the meter is ## Check ribbon cables between boards are connected properly.
"Error Velocity Config Corrupt"	Velocity Tables / Pipe Info not present, corrupt, or unable to find velocity table for configured pipe	<ul style="list-style-type: none"> • Configure the meter for a common pipe (e.i. 6" Carbon Steel Sch40). • If the error disappears, power cycle the unit to confirm if the error no longer exists. • If the error reappears, contact ONICON. RMA needed. The Meter could lost the memory. • If the error is no longer present after changing it to a common pipe, change the pipe configuration to the desired pipe configuration. Confirm the desired pipe configuration exists. Contact ONICON if help is needed to select the correct pipe configuration. • Update firmware on the unit and load a new pipe configuration file using the onicon software.
"Error Pipe Not Configured"	Pipe configuration missing or incomplete	Configure pipe through Pipe Config Settings screen.
"Error Grand Totals Corrupt"	Valid totals could not be retrieved from meter non-volatile storage	<ul style="list-style-type: none"> • Restore Factory Configuration through Utility Menu-> Factory Restore. • Run flow or simulate flow to increase totals. • Power cycle the unit. If the error reappears, contact ONICON support. RMA needed (Meter might lost its memory)
"Error Yearly Totals Corrupt"	Valid totals could not be retrieved from meter non-volatile storage	<ul style="list-style-type: none"> • Restore Factory Configuration through Utility Menu-> Factory Restore. • Run flow or simulate flow to increase totals. • Power cycle the unit. If the error reappears, contact ONICON support. RMA needed (Meter might lost its memory)
"Error Elec 1 Bad DC Offset"	Persistent invalid reading - electrode 1	<ul style="list-style-type: none"> • Power off the unit, and check all wires are connected per the wiring label on the lid • Remove the terminal block on TB8 ELEC1. • Check continuity on cable red and black. (confirm the meter sensor is on water) <ul style="list-style-type: none"> • If there is no continuity. Go to the sensor and open its enclosure, remove terminal P1 ELEC1, and measure continuity on pins A and B. • If there is no continuity, carefully remove the terminal board of the sensor and check if all cables are connected on the back of the board. • If the cables are connected, contact ONICON. RMA need (possible bad stem) • If any cable is corrected during the continuity test, power on the unit and check the error, it should disappear.

ALERT	POTENTIAL ISSUE	POSSIBLE SOLUTION
"Error Elec 2 Bad DC Offset"	Persistent invalid reading - electrode 2	<ul style="list-style-type: none"> • Power off the unit, and check all wires are connected per the wiring label on the lid • Remove the terminal block on TB9 ELEC2. • Check continuity on cable yellow and orange. (confirm the meter sensor is on water) <ul style="list-style-type: none"> • If there is no continuity. Go to the sensor and open its enclosure, remove terminal P3 ELEC2, and measure continuity on pins C and D. • If there is no continuity, carefully remove the terminal board of the sensor and check if all cables are connected on the back of the board. • If any cable is corrected during the continuity test, power on the unit and check the error, it should disappear. • If the cables are connected, contact ONICON. RMA need (possible bad stem)
"Error Elec 1/2 Diff OutRange"	Electrode 1 and 2 readings differ too greatly	Perform the steps on the previous alarm. This alarm is present when one of the electrodes is not behaving on average with the other electrode.
"Error Elec 1 Disconnected"	Erroneous zero flow condition detected - electrode 1 (requires flow)	<ul style="list-style-type: none"> • Power off the unit • Confirm the cable coming from the sensor is connected per the wiring diagram on the transmitter lid. • Confirm the wires at the sensor are connected per the wiring diagram on the enclosure lid. carefully remove the terminal board of the sensor and check if all cables are connected to the back of the board. <ul style="list-style-type: none"> • If all the wires are connected as per the wiring diagrams, carefully remove the terminal board of the sensor and check if all cables are connected on the back of the board. • If any cable is corrected during the continuity test, power on the unit and check the error, it should disappear. • If the cables are connected, contact ONICON. RMA need • Check that meter is properly aligned in the pipe
"Error Elec 2 Disconnected"	Erroneous zero flow condition detected - electrode 2 (requires flow)	
"Error Elec 1 or 2 Wired Backwards"	Flow direction difference detected (requires flow)	
"Comm Board Fail"	Meter unable to communicate with Comm Board	<ul style="list-style-type: none"> • Confirm the meter has a communication board and that it is seated properly. (If no communication board is needed. set network setting to none on the user configuration menu • Confirm the communication board has a solid white LED light on. if it is off, a replacement is needed. • If the problem persists, contact ONICON support

ALERT	POTENTIAL ISSUE	POSSIBLE SOLUTION
"Comm Fail"	Meter unable to communicate over network	<ul style="list-style-type: none"> • Verify comm board is fully seated and white LED is on and not blinking. • Verify proper wiring at comm board terminal block. • Verify End of Line termination resistor is properly set. • Connect the meter to a third-party party BACnet explorer (e.i. YABE) to confirm communication functionality. <ul style="list-style-type: none"> • If the meter is working properly through YABE, then check the meter network setting is acording the trunk or IP setting. • If it is a RS485 network. Chek wiring connection have the proper voltage. Refer to the page for additional help on the voltages of an RS-485 trunk.
"Error Coil Open"	Coil unplugged condition detected	<ul style="list-style-type: none"> • Power off the unit • Confirm the cable coming from the sensor is connected per the wiring diagram on the transmitter lid. • Confirm the wires at the sensor are connected per the wiring diagram on the enclosure lid. carefully remove the terminal board of the sensor and check if all cables are connected to the back of the board. <ul style="list-style-type: none"> • If all the wires are connected as per the wiring diagrams, carefully remove the terminal board of the sensor and check if all cables are connected on the back of the board. • If any cable is corrected during the continuity test, power on the unit and check the error, it should disappear. • If the cables are connected, contact ONICON. RMA needed.
"Error Coil Short"	Coil shorted condition detected	
"Error Coil Out of Range"	Coil voltage outside acceptable threshold	
"Error Flow Wave Cfg Corrupt"	Meter configuration corrupt	Contact ONICON.
"BACnet Object Creation"	Unable to initialize BACnet comms	<ul style="list-style-type: none"> • Confirm the meter has a communication RS485 and IP board is sitted properly. (If no communication board is needed. set network setting to none on the user configuration menu • Confirm the communication board has a solid white LED light on. if it is off, a replacement is needed. • Power cycle the unit. If the problem persists after 60sec, contact ONICON support.

7.0 ALARMS

ALERT	POTENTIAL ISSUE	POSSIBLE SOLUTION
"Alarm Max Velocity"	The actual flow is greater than the volumetric flow rate at 20 ft/s	Nonideal flow rate condition. Contact ONICON if a short high flow rate test is needed
"Alarm High Flow"	Meter has reached HW flow limit of 20 ft/sec, or high limit specified over BACnet	<ul style="list-style-type: none"> Check high limit of Volume Rate BACnet object Nonideal flow rate condition. Contact ONICON if a short high flow rate test is needed
"Alarm AOUT 1 High Flow"	Flow exceeds Analog Out 1 configured range	<ul style="list-style-type: none"> Confirm the analog output full scale is equal to or greater than the design max flow of the system Go to Main Menu -> user configuration-> Input/ Ouput-> Analog Output to adjust the full scale of the meter
"Alarm AOUT 2 High Flow"	Flow exceeds Analog Out 2 configured range	<ul style="list-style-type: none"> Confirm the analog output full scale is equal to or greater than the design max flow of the system. Go to Main Menu -> user configuration-> Input/ Ouput-> Analog Output to adjust the full scale of the meter
"Alarm Freq High Flow"	Frequency out exceeds configured max (GPM)	<ul style="list-style-type: none"> Confirm the frequency output full scale is equal to or greater than the design max flow of the system. Go to Main Menu -> user configuration-> Input/ Ouput-> Frequency Output to adjust the full scale of the meter
"Alarm Empty Pipe"	Empty Pipe condition detected	<ul style="list-style-type: none"> Confirm the pipe is full of water and the meter is properly ground according to section 3.5. Verify the possible solution steps given on "Error Elec 1 Disconnected" Empty pipe can show if Elec1 is disconnected.
"Alarm Warm Up"	Meter is electronics warming up	<ul style="list-style-type: none"> If 3 min have passed, power cycle the unit and wait 3 more min for the alarm to clear off. Contact ONICON if the alarm is still present. RMA needed.
"Alarm Pulse 1 Overrun"	At current flow rate, pulses are occurring faster than configured pulse multiplier and duration - digital port 1	<ul style="list-style-type: none"> Confirm the flow rate data and pipe diameter data on the tag attached to the meter correspond with the actual flow and actual pipe diameter. Any mismatch between the calibrated and actual flow rates or the calibrated and actual pipe diameter will cause this alarm message to appear. Check Pulse Factor, Pulse Duration, and Volume Unit on Digital I/O screen, and Pipe Config Settings screen. If the problem persists, contact ONICON support.
"Alarm Pulse 2 Overrun"	At current flow rate, pulses are occurring faster than configured pulse multiplier and duration - digital port 2	
"Alarm Pulse 3 Overrun"	At current flow rate, pulses are occurring faster than configured pulse multiplier and duration - digital port 3	
"Alarm Digital Out 1 Check Jumpers"	Digital Out direction (in/out) jumper setting incorrect - port 1	Ensure jumpers J1 - J2 are set correctly to match settings in Digital I/O configuration screen
"Alarm Digital Out 2 Check Jumpers"	Digital Out direction (in/out) jumper setting incorrect - port 2	Ensure jumpers J3 - J4 are set correctly to match settings in Digital I/O configuration screen
"Alarm Digital Out 3 Check Jumpers"	Digital Out direction (in/out) jumper setting incorrect - port 3	Ensure jumpers J5 - J6 are set correctly to match settings in Digital I/O configuration screen

8.0 WARNINGS

ALERT	POTENTIAL ISSUE	POSSIBLE SOLUTION
"Warn Reverse Flow"	Flow is flowing contrary to flow direction indicator on meter stem	Not an actual issue present. The warning is present as a message when the flow is going in the opposite direction for bidirectional meters.
"Warn Low Flow"	Flow is below low flow warning threshold (0.25 ft/sec), or low limit specified over BACnet	<ul style="list-style-type: none"> • Verify proper meter installation • Ensure water is flowing in pipe. • Check low limit of Volume Rate BACnet object if applicable.
"Warn High Flow"	Flow is above high flow warning threshold (19 ft/sec)	Reduce flow in pipe
"Warn AOUT 1 Low Flow"	Analog Out flow is below low flow threshold (0.25 ft/sec) - port 1	<ul style="list-style-type: none"> • Verify proper meter installation • Ensure water is flowing in pipe. • Check config in Analog Outputs screen, Pipe Config Settings screen.
"Warn AOUT 1 High Flow"	Analog Out flow is above high flow warning threshold (19 ft/sec) - port 1	<ul style="list-style-type: none"> • Reduce flow in pipe. • Check config in Analog Outputs screen, Pipe Config Settings screen.
"Warn AOUT 2 Low Flow"	Analog Out flow is below low flow threshold (0.25 ft/sec) - port 2	<ul style="list-style-type: none"> • Verify proper meter installation • Ensure water is flowing in pipe. • Check config in Analog Outputs screen, Pipe Config Settings screen.
"Warn AOUT 2 High Flow"	Analog Out flow is above high flow warning threshold (19 ft/sec) - port 2	<ul style="list-style-type: none"> • Reduce flow in pipe. • Check config in Analog Outputs screen, Pipe Config Settings screen.
"Warn AOUT 1 HW Failure"	Analog output controller hardware reports temperature exceeds max threshold (142 C) - Analog Out port 1	Verify meter operating environment temperature is within listed specification (-20°F to 150°F). If problem persists contact ONICON support.
"Warn AOUT 1 Open Circuit or Bad Voltage"	Analog output controller hardware reports open circuit or bad voltage - Analog Out port 1	<ul style="list-style-type: none"> • Check Power to the transmitter is ## • Check Analog Output 1 connection in the transmitter. • Verify Analog Output 1 wiring to BAS to ensure correct no wires are damaged or crossed. • Verify configuration of Analog Input at BAS. • If problem persists, contact ONICON support
"Warn AOUT 1 Communications Fail"	Analog output controller hardware reports communications failure - Analog Out port 1	Contact ONICON. RMA needed
"Warn AOUT 1 Timeout"	Analog output controller hardware reports execution timeout - Analog Out port 1	Contact ONICON. RMA needed
"Warn AOUT 2 HW Failure"	Analog output controller hardware reports temperature over max threshold (142C) - Analog Out port 2	Contact ONICON. RMA needed
"Warn AOUT 2 Open Circuit or Bad Voltage"	Analog output controller hardware reports open circuit or bad voltage - Analog Out port 2	<ul style="list-style-type: none"> • Check Power to the transmitter is ## • Check Analog Output connection in the transmitter. • Verify Analog Output wiring to BAS to ensure correct no wires are damaged or crossed. • Verify configuration of Analog Input at BAS. • If problem persists, contact ONICON support.

ALERT	POTENTIAL ISSUE	POSSIBLE SOLUTION
"Warn AOUT 2 Communications Fail"	Analog output controller hardware reports communications failure - Analog Out port 2	Contact ONICON. RMA needed
"Warn AOUT 2 Timeout"	Analog output controller hardware reports execution timeout - Analog Out port 2	Contact ONICON. RMA needed
"Warn Freq High Flow"	Flow exceeds configured high flow threshold (95% of max FreqOut flow)	<ul style="list-style-type: none"> • Confirm the frequency output full scale is equal to or greater than the design max flow of the system. • Go to Main Menu -> user configuration-> Input/ Ouput-> Frequency Output to adjust the full scale of the meter
"Warn Low Internal Regulator"	Internal power regulator below acceptable threshold	Contact ONICON. RMA needed
"Warn Low Isolated Regulator"	Analog I/O power regulator below acceptable threshold	Contact ONICON. RMA needed
"Warn RTC Fail"	Real time clock chip malfunction	Contact ONICON. RMA needed
"Warn Elec 1 Flow Unstable"	Minor reading irregularities detected - electrode 1	<ul style="list-style-type: none"> • Verify the meter is installed at the correct location in the system and installed at the correct height offset to ensure the sensor is in the correct portion of the pipe. • Verify system is properly bled and that no air is trapped in the piping system where the sensor is placed. • Disconnect power from the device and check Electrode 1 wiring connections at sensor and transmitter ends of wire. • Check continuity along each Electrode 1 wire to verify wire connection between the sensor and transmitter. • Also, check Electrode 1 wiring for continuity between other wires, ground, or either body. If problem persists Contact ONICON support.
"Warn Elec 2 Flow Unstable"	Minor reading irregularities detected - electrode 2	

ALERT	POTENTIAL ISSUE	POSSIBLE SOLUTION
"Warn Elec 1 Noise"	Noise level measured at electrode 1 is significantly higher than electrode 2	<ul style="list-style-type: none"> • Verify the meter is installed at the correct location in the system and installed at the correct height offset to ensure the sensor is in the correct portion of the pipe. • Review install location of the sensor and disply to ensure they are not unacceptably close to sources of electronic interference or noise (pumps, VFDs, or other high power equipment).
"Warn Elec 2 Noise"	Noise level measured at electrode 2 is significantly higher than electrode 1	<ul style="list-style-type: none"> • Disconnect power from the device and check Electrode 1/2 wiring connections at sensor and transmitter ends of wire. • Check continuity along each Electrode 1/2 wire to verify wire connection between the sensor and transmitter. • Also, check Electrode 1/2 wiring for continuity between other wires, ground, or either body. If problem persists Contact ONICON support.
"Warn Pulse 1 Invalid Cfg"	Flow at 20 ft/sec would exceed configured pulse configuration - port 1	<ul style="list-style-type: none"> • Confirm the flow rate data and pipe diameter data on the tag attached to the meter correspond with the actual flow and actual pipe diameter. • Any mismatch between the calibrated and actual flow rates or the calibrated and actual pipe diameter will cause this alarm message to appear. • Check Pulse Factor, Pulse Duration, and Volume Unit on Digital I/O screen, and Pipe Config Settings screen. If the problem persists, contact ONICON support.
"Warn Pulse 2 Invalid Cfg"	Flow at 20 ft/sec would exceed configured pulse configuration - port 2	
"Warn Pulse 3 Invalid Cfg"	Flow at 20 ft/sec would exceed configured pulse configuration - port 3	
"Warn Fact Defaults Corrupt"	Factory defaults missing. (Factory Restore feature can not be used.)	<p>Update firmware on both the main board and communication board. Refer to page # for the firmware update procedure.</p> <p>If problem persist, contact ONICON. RMA needed</p>

ALERT	POTENTIAL ISSUE	POSSIBLE SOLUTION
"Warn Flow Sample Overrun 1"	Meter internal error - performance may be impacted	Contact ONICON. RMA needed
"Warn Coil BIT Samp Overrun 1"	Meter internal error - performance may be impacted	Contact ONICON. RMA needed
"Warn Flow Sample Overrun 2"	Meter internal error - performance may be impacted	Contact ONICON. RMA needed
"Warn Coil BIT Samp Overrun 2"	Meter internal error - performance may be impacted	Contact ONICON. RMA needed
"Warn Flow Sample Trans Error"	Meter internal error - performance may be impacted	Contact ONICON. RMA needed
"Warn Coil BIT Samp Trans Error"	Meter internal error - performance may be impacted	Contact ONICON. RMA needed
"Warn Flow Sample Near Full"	Meter internal error - performance may be impacted	Contact ONICON. RMA needed
"Warn Coil BIT Samp Near Full"	Meter internal error - performance may be impacted	Contact ONICON. RMA needed
"Warn UART Tx Error"	Meter internal error - performance may be impacted	Contact ONICON. RMA needed
"Warn UART Rx Error"	Meter internal error - performance may be impacted	Contact ONICON. RMA needed
"Warn UART Tx Hang"	Meter internal error - performance may be impacted	Contact ONICON. RMA needed
"Warn Meter Temp"	Meter internal CPU temperature outside operating limits: 34 F to 185 F	Verify meter operating environment temperature is within listed specification (-20°F to 150°F). If problem persists contact ONICON support.
"Warn Comm Board Compat Error"	Comm Board message protocol error	Update firmware on both the main board and communication board. Contact ONICON for an update procedure or visit our website for an Update Procedure TechNote.
"Warn SPI/I2C Transient Error"	Transient error detected on meter internal communication bus	Contact ONICON. RMA needed

APPENDIX 1
INPUT POWER AND SENSOR CONNECTION FOR DECEMBER 2024/JANUARY 2025 CABLE VARIANT

TB8 Elec1	SHIELD, RED, BLACK
TB9 Elec2	SHIELD, GREEN, BLACK
TB2 Coil	WHITE, BLACK, SHIELD

